



# ALVA

## PATIO HEATER POWDER COATED

GHP17



Your world is better with Alva

- THIS IS A LOW PRESSURE APPLIANCE TO BE USED ONLY WITH A 2.8kPa SANS 1237 APPROVED REGULATOR. (REGULATOR FITTED AND SUPPLIED)
- FOR YOUR OWN SAFETY, PLEASE READ THIS MANUAL CAREFULLY AND ALWAYS OPERATE THIS PRODUCT ACCORDING TO THE INSTRUCTIONS
- IT IS ILLEGAL AND DANGEROUS TO CHANGE OR MODIFY ANY PART OF THIS APPLIANCE

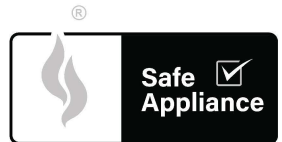

APPROVED FOR USE IN  
SOUTH AFRICA

Manufactured for  
and distributed by:



# ALVA

A division of Stingray Accessory Manufacturers (Pty) Ltd | P.O. Box 30014, Tokai, 7966  
+27 21 442 1540 | info@stingray.co.za | www.alva.co.za  
TOLL FREE NUMBER: 086 100 ALVA (2582)

 /AlvaGas

 /alvagas

## IMPORTANT SAFETY INFORMATION

As with all gas appliances, misuse of this appliance or failure to fully follow these instructions may cause fire, injury or death. Please read all the instructions before using your gas heater.

- THIS UNIT MUST BE THOROUGHLY CHECKED BEFORE USE.
- Ensure that all the gas fittings are correctly and firmly fitted before every use.
- Remove all packaging materials before assembling.
- For OUTDOOR USE ONLY. Not for commercial use.
- For use with LP gas only
- DO NOT use within 1m of any flammable surfaces
- DO NOT use this patio heater if you do not clearly understand the instructions and/or how to operate the controls.
- Phone the customer care line at 086 100 ALVA (2582) or email [info@stingray.co.za](mailto:info@stingray.co.za) for assistance.
- DO NOT store flammable materials or another cylinder near the patio heater.
- DO NOT leave the heater unattended while in use.
- Ensure that the gas supply is turned OFF at the cylinder after use and while the heater is unattended.
- DO NOT move the heater while in use.
- DO NOT place objects on or against the heater.
- DO NOT use a naked flame to test for leaks. Follow the Leak Testing procedure outlined under 'LEAK TEST'.
- Leak test the patio heater every year or if you ever smell gas
- NEVER use this heater with a cylinder other than the size recommended.
- DO NOT unscrew the regulator while the patio heater is on or if the cylinder valve is open.
- DO NOT use a patio heater you suspect is faulty.
- For safety reasons, only a qualified technician may execute maintenance and repairs.
- The warranty for the patio heater will be rendered void if the patio heater is serviced or repaired by any one other than an Alva appointed technician.
- The patio heater should be inspected once a year by a qualified technician, to make sure the unit is safe and fault free.
- The operator is responsible for the safety of all third parties while the heater is in use.
- DO NOT use in windy or gusty conditions.
- Accessible parts may get very hot during operation. Keep young children at a safe distance.
- Clean with warm soapy water only after the heater has cooled down.
- Keep the burner unit clear of spider webs or other obstructions.
- Close the gas cylinder valve off after use.
- Any modification of this heater is dangerous.
- If you smell gas close the cylinder valve immediately.



*Please read the instructions carefully before use.*

*Retain this manual for future reference.*

## INDEX

WARRANTY	1
GENERAL INFORMATION	1
ASSEMBLY	2
HEATER SET UP	2
PARTS DIAGRAM	7
PARTS LISTING AND TOOLS REQUIRED	8
LEAK TEST	9
USING YOUR HEATER	9
FLASHBACK (flames in the burner tube)	10
CHANGING YOUR CYLINDER	11
MAINTENANCE	11
FREQUENTLY ASKED QUESTIONS	12
SPECIFICATIONS	13
TROUBLESHOOTING GUIDE	14
AFTER SALES SERVICE	14

### KEY



*Important information*



*Cautions and warnings.*



*Danger*



*Contact an approved ALVA technician.*



*Do It Yourself*



*Instructional video available*

## WARRANTY

### PLEASE RETAIN YOUR PROOF OF PURCHASE FOR WARRANTY CLAIMS.

ALVA warrants this appliance to be free of defects in material and quality for a period of 12 months from date of original purchase. This warranty covers the intended use of this appliance – within a domestic setting and not for commercial or industrial purposes. Any damage caused by wilful abuse, tampering, modification or unauthorized repair will not be warranted.

Please retain all packaging material, as items returned without original packaging material may be subject to a withholding fee. Where this appliance is found to be defective, damaged, broken, or does not work correctly for the intended purpose, you must return the appliance to the retailer from where it was purchased. The warranty will only be effected with valid proof of purchase. Failure to provide the proof of purchase will most likely result in the repair or service required being chargeable.

If you have any questions while setting up or using this heater, please visit [www.alva.co.za](http://www.alva.co.za) or call 086 100 ALVA (2582) or e-mail [info@stingray.co.za](mailto:info@stingray.co.za)

## GENERAL INFORMATION

Before using this heater, please read through this manual and make sure you understand everything. If you are not sure, call **086 100 ALVA (2582)** or visit [www.alva.co.za](http://www.alva.co.za) for help. This heater is a safe and efficient form of heating when used according to these instructions.

Reading and understanding this manual should give you a good indication of what to expect from your Alva gas heater. If this product is not what you want or need, please help Alva and the environment by not damaging or destroying any part of the packaging, the manual or the Styrofoam inserts. Always keep your proof of purchase. Keep these instructions for future use. If you lose this copy, you can obtain a new copy from your dealer or online at [www.alva.co.za](http://www.alva.co.za).

This appliance operates on a 2.8kPa SANS 1237 approved regulator. Regulator and hose included.



*Thank you for your purchase of this instant infrared heater. Please read these instructions carefully before use and keep them in a safe place, for future reference.*



*Not using gas and/ or gas appliances according to the instructions is extremely dangerous and can lead to property damage, injury or death.*

*For outdoor use only.*

*For use with LPG only*

*DO NOT use within 1m of any flammable surfaces.*

*Always turn OFF the gas supply at the cylinder after use.*

*DO NOT store flammable materials or another cylinders near the heater.*

## ASSEMBLY

Remove all packaging materials before assembling the patio heater.

Before Assembly:

- Please read all instructions thoroughly before proceeding with the appliance assembly.
- Find a large clean area in which to assemble the patio heater.
- Please refer to the parts list and diagrams. (see page 7)
- Assembly of the heater involves large components and it is advisable to have two people to assemble the unit.

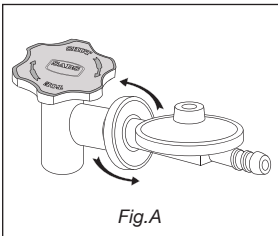

This patio heater makes use of an industrial cylinder (9kg ALVA cylinder recommended) with a 5/8" BSP thread; horizontal exit valve. The Bullnose regulator supplied with the heater tightens to the left hand side (anti-clockwise). (*Figure A*).

If you have bought a new gas cylinder, the cylinder needs to be purged (emptied out), before it's first use. If it is not purged of air, the heater will not work properly. This should happen at the gas filling station when you fill up the cylinder. Always check this with your gas supplier.

## HEATER SET UP

1. Before removing this heater from the packaging, read this manual in full and make sure that it is what you want /need.
2. Remove the heater from the packaging
3. Check if the nose cone sealing washer is in place, secure and in good condition. (*Figure B*)
4. The regulator goes directly into the cylinder valve. Always ensure that the regulator is correctly and firmly fastened in place. The use of any adaptors is illegal.

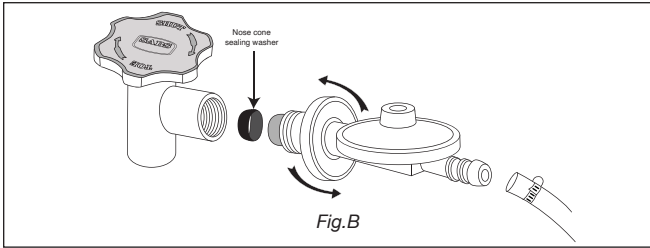

Your heater should be checked once a year by a qualified technician. Take special care to retighten any fixtures or nuts and bolts that have come loose.

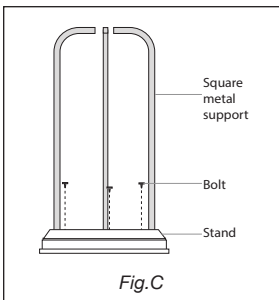

5. Place the 3 post brackets into position on the base. Use three M8 x 16mm bolts to join the post brackets to the stand. (Figure C)

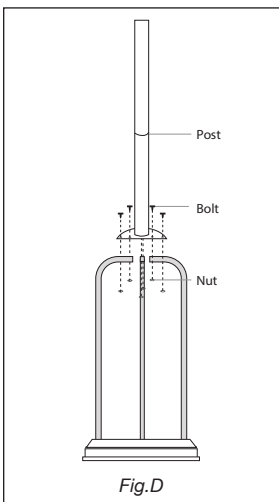

6. Secure the top post above the bottom post by sliding each post into each other. Secure the post by using the six M6 x 35mm bolts and nuts to connect the post to three post brackets. Tighten the bolts and nuts securely. (Figure D)

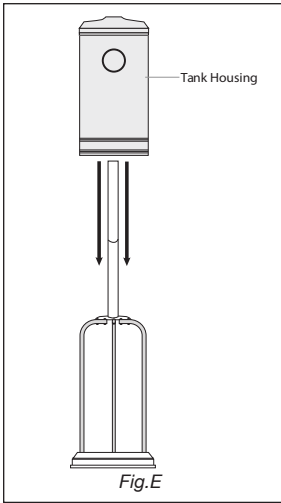

7. Place the tank housing over the stand and down onto the weighted foot piece. (Figure E)

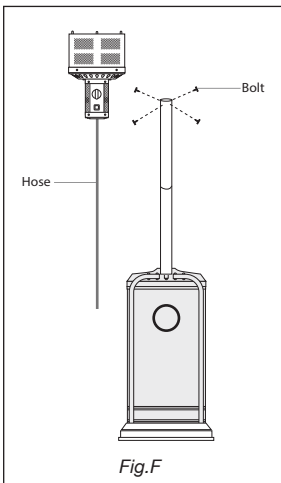

8. Take the burner head with the attached hose and feed the supply hose through the hollow centre of the post. Secure the assembled burner head unit to the top section of the post using four M6 x 10mm bolts; ensure that the warning and ignition instructions are positioned with the control / ignition valve selector knob both in view. Attach the supplied regulator to the hose end.(Figure F)



*Tip:*  
Warm the hose by placing it in hot water for a minute to ease the hose fitting over the regulator nipple.

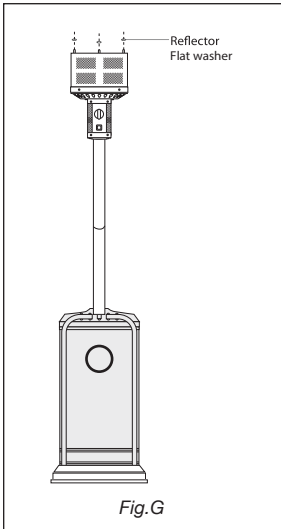

9. Tighten all loose nuts and bolts. Place a  $\varnothing 8\text{mm}$  on each reflector support bolt. (Figure G). Do a final check to be certain that all nuts and bolts are securely fastened.

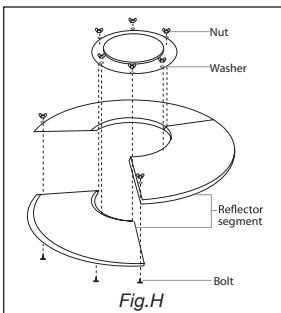

10. Assemble the 4 piece reflector according to Figure H.

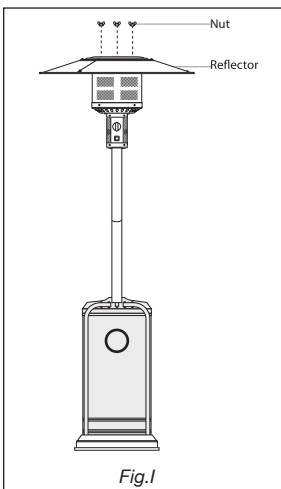

11. Fasten the reflector with three washers and three M8 x 8mm castle nuts. (Figure I)



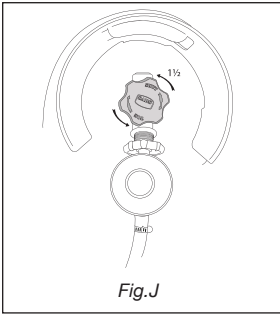



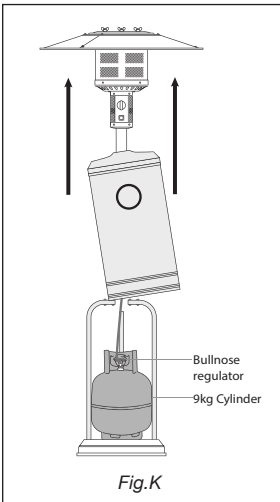





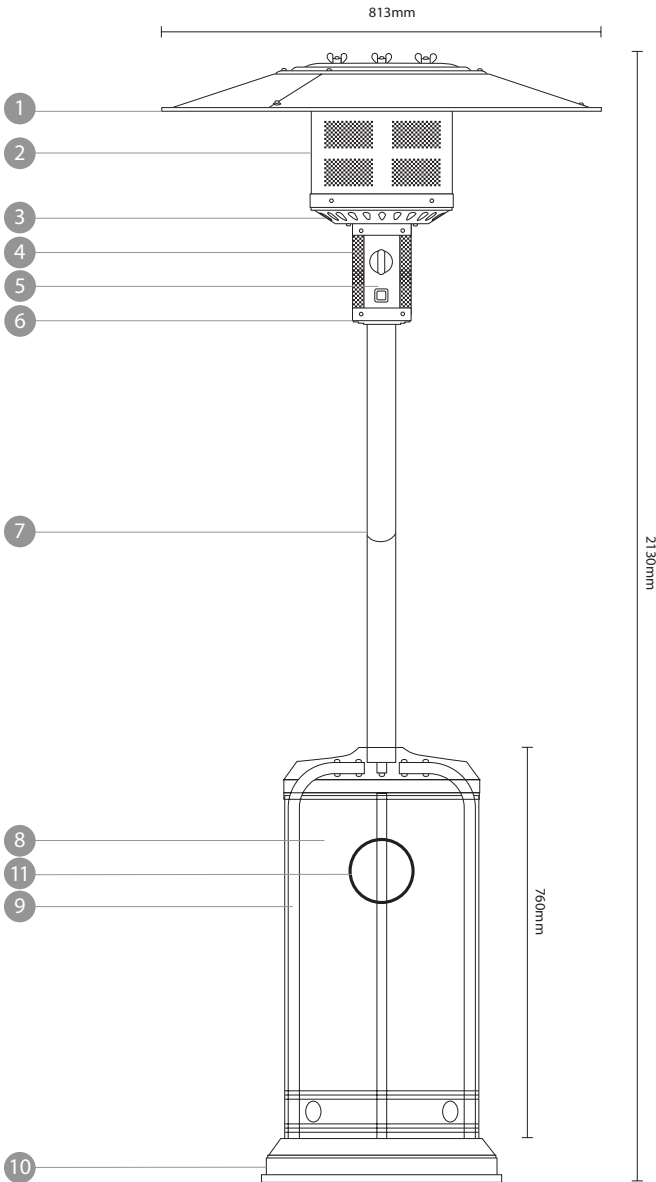













12. Lift up the tank housing and rest it on the post plate. Screw the regulator into the cylinder valve. DO NOT use a tool to tighten the regulator; it is to be hand-tightened only. Open the cylinder valve  $1\frac{1}{2}$  turns to the left (anti-clockwise). (Figure J) Put LPG gas tank on the stand. (Figure K)



13. Perform leak test.

## PARTS DIAGRAM



1	Reflector	 
2	Flame Screen / Emitter Grid	 
3	Burner base	 
4	Air admittance fence	 
5	Gas valve controller	 
6	Base of control Housing	 
7	Post	 
8	Tank housing	 
9	Tank housing support	
10	Stand	 
11	Access and observation port hole	 

Refer to your 'Key' on the index page.

## PARTS LISTING AND TOOLS REQUIRED

<b>PARTS SUPPLIED</b>	<b>QUANTITY</b>
Stand	x1
LPG cylinder housing	x1
Assembly post	x1
Post brackets	x3
Galvanized steel pipe 10mm x 86cm	x1
Reflector 813mm	x1
ø8mm washer	x9
M8 Castle nut	x3
M8 Burner/Reflector support bolt	x3
M6 x 10mm Bolt (for assembly of post and burner)	x4
M6 x 35mm Bolts and nuts (for post and post brackets)	x6
M8 x 16mm Bolts and nuts (for post brackets and stand)	x3
Ground fixer	x3
M6 x 10mm Ground fixer bolts and nuts	x6

<b>TOOLS NOT SUPPLIED</b>	<b>QUANTITY</b>
Open end wrench 10 x 13mm	x1
Adjustable opening wrench (2) 20cm long	x1
Slip joint pliers 23cm long	x1
Phillips screwdriver with medium blade	x1
Spray bottle of soap solution for leak test (see page 9)	x1

## LEAK TEST

The leak test must be carried out in a well-ventilated area, free from any flames or other sources of ignition.

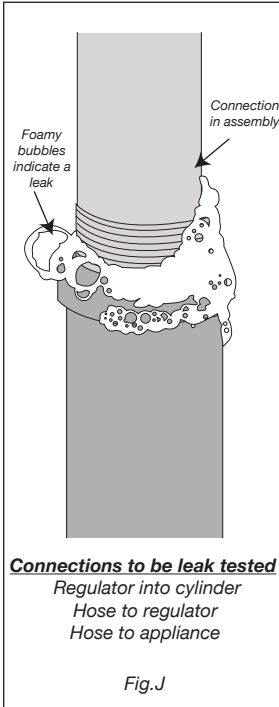

- With the cylinder connected to the heater. Open the cylinder valve.
- Brush the connections (heater to cylinder) with a solution of equal parts soap and water (make sure it's foamy).
- A stream of bubbles forming indicates a gas leak. (See Fig.J)
- If bubbles appear, turn the cylinder valve OFF (clockwise) and disconnect the heater from the gas cylinder.
- Tighten the connection and retry the leak test.
- If you are unsure or if you cannot tighten the connection, place the cylinder outside in a cool, well-ventilated area and contact Alva on **086 100 ALVA (2582)**.
- A leak between the heater and cylinder can lead to a high pressure fire, which is very dangerous and can result in extensive injury or even death.

## USING YOUR HEATER

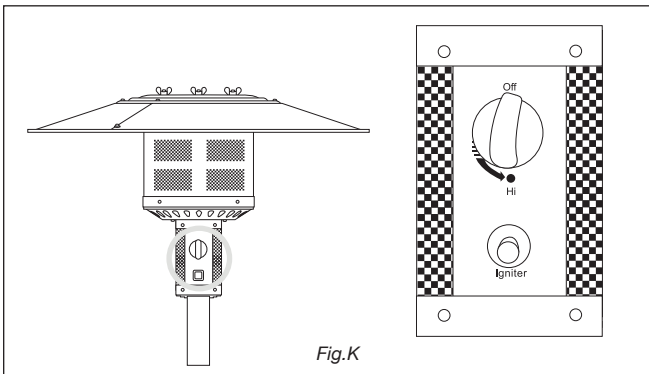

How to do  
a leak test



<http://www.youtube.com/watch?v=8LpZ1B0m23Y&feature=plcp>



**FOR YOUR SAFETY  
IF YOU SMELL GAS**

- Turn off the gas supply at the bottle.
- Extinguish all naked flames. **DO NOT** operate any electrical appliances.
- Ventilate the area.
- Check for leaks (see LEAK TEST)
- If odour persists, contact your dealer or local gas supplier immediately.



Before proceeding to ignite the heater, make sure you understand the "IMPORTANT SAFETY INFORMATION" section of this manual.

### Lighting of the Patio Heater:

1. Check all the connections for leaks or damage prior to each use.
2. Turn the gas control knob to the OFF position.
3. Open the gas cylinder valve 1½ turns (anti-clockwise).
4. Gently push in the control knob on the heater and turn it to the HI position.
5. Keeping the control knob depressed, press the igniter button. The burner will ignite. Keep the knob depressed for another 10 seconds to allow the flame failure safety device to activate.
6. Once the burner ignites, select your required heat setting.
7. When lighting the heater the first time, you may have to keep the control knob depressed a little longer to allow any air in the system to clear.
8. If the heater does not ignite the first time, wait for 5 minutes and repeat the lighting instructions. If you still experience ignition problems, contact 086 100 ALVA (2582) for assistance.

### Turning the Patio Heater Off:

1. Close the cylinder valve (clockwise).
2. Turn the heater control knob to the OFF position.
3. DO NOT attempt to relight the heater for at least 10 minutes.

### Visual inspection of the burner flame:

The flame pattern on the flame screen (Emitter grid) should become evenly bright red while the heater is burning. The heater should be turned off immediately if either of the following conditions are observed:

1. When the flame extends more than 10 to 15mm beyond the surface of the Flame Screen (Emitter grid)
2. When black soot accumulates on the Flame Screen (Emitter Grid)

## **FLASHBACK (flames in the burner tube)**

If a flash back occurs (indicated by a roaring noise), immediately close the cylinder valve.

- Turn the heater OFF at the control knob.
- Disconnect the regulator and allow the heater to cool.
- Check for blockages in the burner head. Clean with compressed air, a small soft brush or pipe cleaners.
- If the problem persists, have the heater checked by a qualified technician.



*Smoke and odour caused by the heating of oils used during manufacturing will occur when lighting the heater for the first time. This is normal and there is no reason for alarm. Avoid inhaling the fumes!*

*The smoke and odour should dissipate within 3 - 4 minutes.*

## CHANGING YOUR CYLINDER

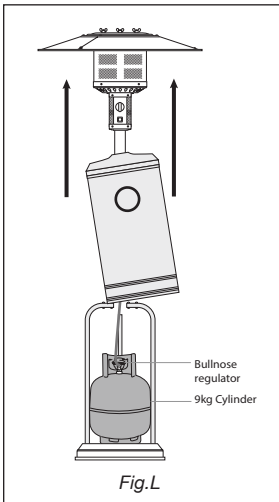

Make sure your cylinder valve is closed (by turning it clockwise). Allow the heater to fully cool before replacing the cylinder. Open the heater to expose the cylinder. Lift up the tank housing and tilting it so that the tank housing support holds the tank housing up, exposing the cylinder fully. Allowing you to access and replace the cylinder. (Figure L)

Remove and replace the cylinder. ALWAYS check that the regulator-sealing washer (nose cone) is intact and in place before reattaching the regulator to a cylinder. (Figure B - Page 3)

DO NOT attempt to remove the regulator while the heater is on or if the cylinder valve is not closed.

## MAINTENANCE

- Always make sure the heater is OFF and cool, with the cylinder valve closed, before conducting any maintenance.
- Your heater should be checked once a year by a qualified technician.
- If faults are suspected or detected, stop using the heater and contact ALVA.
- Clean the exterior and storage area of your heater when required to remove dust.
- DO NOT use abrasive products to clean the heater; these may damage the paint work.
- Check the burner and remove any debris, dirt, spider webs or wasp nests from the burner ports by using compressed air or a pipe cleaner. DO NOT clean the burner with water or tamper with the jets. If a jet is blocked it must be replaced with an original manufacturer marked jet.
- Replace parts and allow the heater to dry properly before storing.
- If the gas control or ignitor is exposed to water or gets wet, dry it properly before attempting to light the heater. You might have to replace the parts if the heater does not ignite.

- The airflow must not be obstructed. Keep the controls and burner passage clean.

Clean with a soft brush or blow clean with compressed air.

If any part of the heater is in need of replacing, use only original Alva parts. Using any other spare parts is dangerous and will void the warranty.

When the heater is not in use for extended periods, always keep the burner head covered.

Your heater should be checked once a year by a qualified technician. Take special care to retighten any fixtures or nuts and bolts that have come loose.

#### Signs of a blockage:

1. Gas odour with extreme yellow tipping of the flame
2. Heater does not reach the desired temperature
3. Heater glow is excessively uneven
4. Heater making popping sounds
5. Heater 'Flashes back' in burner tube

#### Storage

Store the heater in a cool dry place. If in a coastal area extra care must be taken in selecting the storage area as rust will occur if exposed to the elements. Disconnect the cylinder and store separately in a protected dry and cool place.

Alva recommends that you cover your heater. Full length covers are available as optional extras.

#### Cleaning and care

- Wipe off all surfaces with a soft, moist rag. DO NOT clean the heater with combustible or corrosive cleaners.
- Remove debris from the burner to keep it clean and safe for use.
- In order to prolong the life of your heater we recommend oiling all stainless surfaces, with exception of the reflector, flame screen and burner base, on a regular basis. This is especially important near the coast.

## FREQUENTLY ASKED QUESTIONS

**Q:** Why is there an odour when I use a gas heater?

**A:** All gas appliances give off an odour. This could be harmful if inhaled for extended periods of time. This "smell" is normal, and it does not mean that you have a gas leak. The smell of raw gas (just before you ignite the appliance) differs to the smell coming from the heater when it is in use. The odour is added to allow easy gas detection.

**Q: Why must there be ventilation when using a gas heater?**

**A:** Whenever fuel (LP Gas in this case) is burned, ventilation is needed. Any fire needs oxygen to burn. Think of a fireplace, you require a chimney or flue for the smoke to exit the house. Even though a gas heater does not generate smoke, it still generates carbon monoxide and carbon dioxide, which can be dangerous if not diluted by fresh air. Always ensure adequate ventilation by leaving a door or window open in the same room.

**Q: How long will the gas in my cylinder last?**

**A:** This depends on how you use your heater. It is easy to calculate your gas consumption. Take the capacity of the gas cylinder in grams (i.e. 9000g for a 9kg cylinder) and divide it by the gas consumption of the heater, on your desired setting (refer to the Technical Data section in this manual (page 13)). The answer to the calculation is the approximate number of hours that your heater will burn for.

**Q: What do I do if I have an over-filled cylinder?**

**A:** The best method to determine if your cylinder is over-filled is to weigh it. Subtract the 'tare' mass from the cylinder weight – this gives you the weight of your gas. If this gas weight exceeds your cylinder design weight (9kg) then return the cylinder to your gas supplier.

## SPECIFICATIONS

Model	GHP17
Type of Gas	LPG
Operating pressure	2.8kPa
Injector size	1.90mm
Gas Consumption	870gr/hr at MAX
Heat output	13kW
This appliance operates with a Bullnose 5/8" BSP left hand thread with a 2.8kPa SANS 1237 approved 1kg/hr flow rate regulator. Regulator supplied.	



*How to test if your cylinder is overfilled*



<http://www.youtube.com/watch?v=YavsYE8nzCw&feature=plcp>



## TROUBLE SHOOTING GUIDE

TROUBLE	CAUSE	REMEDY
Burner will not light	Pressure is low	Cylinder near empty. Refill LPG Cylinder.
	Opening blocked	Remove burner and clean it
	Control not on HI	Turn Control Valve to HI
	Thermocouple faulty	Replace Thermo-couple
	In poor location	Position properly and retry

## AFTER SALES SERVICE

### MANUFACTURED AND DISTRIBUTED BY

Alva Marketing (Pty) Ltd

P.O. Box 30014

Tokai, 7966

Tel: 021 442 1540

E-mail: [info@stingray.co.za](mailto:info@stingray.co.za)

[www.alva.co.za](http://www.alva.co.za)

 [alvagas](#)

 [www.facebook.com/AlvaGas](http://www.facebook.com/AlvaGas)

TOLL FREE NUMBER **086 100 ALVA (2582)**