



ALVA

STAINLESS STEEL GAS HOB



GDH100 60cm



GDH101 90cm

Your world is better with Alva

- THIS IS A LOW PRESSURE APPLIANCE TO BE USED ONLY WITH A 2.8kPa SANS 1237 APPROVED REGULATOR AND SANS 1156 APPROVED HOSE, BOTH NOT INCLUDED.
- FOR YOUR OWN SAFETY, PLEASE READ THIS MANUAL CAREFULLY AND ALWAYS OPERATE THIS PRODUCT ACCORDING TO THE INSTRUCTIONS
- IT IS ILLEGAL AND DANGEROUS TO CHANGE OR MODIFY ANY PART OF THIS APPLIANCE



APPROVED FOR USE IN
SOUTH AFRICA

Manufactured for
and distributed by:



ALVA
The world starts with Alva

A division of Singray Accessory Manufacturers (Pty) Ltd | P.O. Box 30060, Tokai, 7960
+27 21 442 1540 | info@singray.co.za | www.alva.co.za
TOLL FREE NUMBER: 086 193 ALVA (1542)

@/alvagas

f /Alvagas

IMPORTANT SAFETY INFORMATION



Thank you for your purchase of this gas hob.

Please read these instructions carefully before use and keep them in a safe place for future reference.



See installation section on pages 5 - 7 for more information

- Read these instructions carefully before using your gas hob.
- The operator must understand all safety requirements as detailed in this manual before using the unit.
- The operator is responsible for the safety of all third parties while the hob is in use.
- The manufacturer's warranty may be voided by incorrect use of this product.
- If you have any queries regarding these instructions, contact your local dealer for clarification before you use your hob.
- Failure to follow the manuals instructions could result in damage or serious injury.
- When this appliance is to be permanently installed the installation should only be carried out by a qualified gas fitter who is registered with LPGSASA and that such installations should comply with the requirements of SANS 10087-1 or SANS 827 as applicable.
- Before installation, thoroughly check the hob and ensure it is in working condition. Should any problems occur, please contact the manufacturer.
-
- Ensure that the hob is positioned on an even and secure surface before operating.
- This appliance cannot be installed on yachts or in caravans.
- This appliance must only be used in well ventilated places.
- This appliance is not intended for operation with an external clock timer or a remote control.
- Ensure that all gas fittings are correctly and firmly fitted.
- DO NOT store flammable materials near the hob.
- DO NOT place or use aerosol sprays near the hob.
- Use only the gas type specified on the nameplate of the unit, LPG
- DO NOT leave the hob unattended when it is alight.
- Onlookers should keep a safe distance away from the hob when it is in use.
- Keep children and animals well away while the hob is in use.
- Parts of the hob will get extremely hot and could cause serious burns - test every surface before touching it.
- Be very careful when operating the hob. The operator should pay constant attention to the food being cooked and should remain at the appliance at all times when it is alight.
- Ensure that the gas supply is turned OFF after use and while the hob is unattended.
- Do not clean or maintain the appliance before it has been switched off and is cool to the touch.

- Please keep children away from any packaging materials, such as plastics, foam and nails as these can be harmful.
- When not in use, make sure that children are kept clear of this appliance.
- This appliance should only be operated by adults, children should not be allowed to use or play with this appliance.
- Keep children clear of this appliance while in use.

- Neither the Manufacturer nor their Agents can accept any liability for the unsuitability of, or any damage to, any food cooked on this appliance.
- This appliance has been designed for home use only, not for commercial or professional use. This appliance is only intended for cooking purposes, not as a heating system.
- Any modification to the hob may cause injury or property damage.
- Any modification to the hob will invalidate the warranty on this appliance.

INDEX

WARRANTY	3
GENERAL INFORMATION	3
CONFIGURATION	4
CONTROLS	4
INSTALLATION	5 - 7
LEAK TEST	8
FITTING AND CHANGING THE GAS CYLINDER	8 - 9
OPERATING INSTRUCTIONS	9 - 11
FLASHBACK	11
CLEANING AND MAINTENANCE	11 - 13
TROUBLESHOOTING GUIDE	13 - 14
SPECIFICATIONS	14 - 15
AFTER SALES SERVICE	15

KEY

Notes marked with the following;



Contain important information

Notes marked with the following;



Contain cautions and warnings.

WARRANTY

PLEASE RETAIN YOUR PROOF OF PURCHASE FOR WARRANTY CLAIMS.

ALVA warrants this appliance to be free of defects in material and quality for a period of 12 months from date of original purchase. This warranty covers the intended use of this appliance – within a domestic setting, and not for commercial or industrial purposes. Any damage caused by wilful abuse, tampering, modification or unauthorized repair will not be warranted.

Please retain all packaging material, as items returned without original packaging material may be subject to a withholding fee. Where this appliance is found to be defective, damaged, broken, or does not work correctly for the intended purpose, you must return the appliance to the retailer from whom it was purchased. The warranty will only be effected with valid proof of purchase. Failure to provide the proof of purchase will most likely result in the repair or service required being chargeable.

If you have any questions while setting up or using this gas hob, please visit www.alva.co.za or call 086 100 ALVA (2582) or e-mail info@stingray.co.za

GENERAL INFORMATION

Before using this hob, read through this manual and make sure you understand everything. If you are not sure, please call 086 100 2582 or visit www.alva.co.za for help.

This hob is a safe and efficient form of cooking food when used according to these instructions.

Reading and understanding this manual should give you a good indication of what to expect from your Alva gas hob.

If this product is not what you want or need, please help Alva and the environment by not damaging or destroying any part of the packaging, the manual or the Styrofoam inserts. Always keep your proof of purchase.

Keep these instructions for future use. If you lose this copy, you can obtain a new copy from your dealer or online at www.alva.co.za



Read Important Safety Information at the beginning of this manual.



Not using gas and or gas appliances according to the instructions is extremely dangerous and can lead to Property damage, injury or death.

CONFIGURATION

GDH100, 60cm 4 burner hob
Pmax 7.8kW

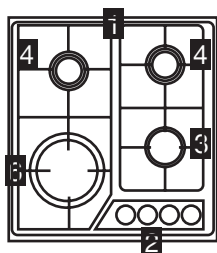

GDH101, 90cm 5 burner hob
Pmax 10.8kW

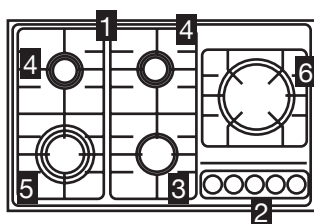

- 1** Cast Iron Pan Supports
- 2** Control Knobs
- 3** Auxiliary Burner
- 4** Semi Rapid Burner
- 5** Rapid Burner
- 6** Wok Burner



1.0kW max	ø55mm
1.75kW max	ø75mm
3.0kW max	ø100mm
3.3kW max	ø130mm

CONTROLS

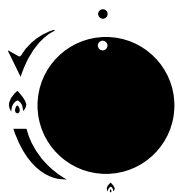
Each control knob is marked with the burner it controls. You can use the control knobs to set the output required in each case to various positions between the maximum and minimum settings.



Burner controlled by control knob

- Burner off position
-  Highest power setting and automatic ignition
-  Lowest power setting



Make sure that the place you choose to install the appliance has easy access to adequate ventilation. Open a window when the appliance is operational for long periods of time.

INSTALLATION

This appliance is designed for use with LPG ONLY. When this appliance is to be permanently installed the installation should only be carried out by a qualified gas fitter who is registered with LPGSASA and that such installations should comply with the requirements of SANS 10087-1 or SANS 827 as applicable.

- Good room ventilation is vital for the efficient performance of the appliance and for the safety of the occupants in the room in which the appliance is installed.
- Cooking appliances generate considerable heat. The layout and materials of the surrounding cabinets should take account of these characteristics.
- Surfaces of cabinets immediately adjacent to the hob should be able to withstand temperature of up to 100°C without delaminating or discolouring.
- Make sure that the unit is well levelled in relation to the ground. Improper levelling can affect the function of the appliance.
- Ensure no items which can catch alight easily (eg. curtains) are near the gas hob.
- Allow an unrestricted air space of at least 150mm at the sides and 750mm above the hob.

Diagrams below show the aperture dimensions in the work top to install the gas hob

4 BURNER HOB

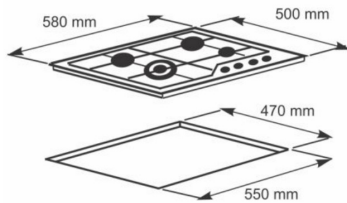

5 BURNER HOB

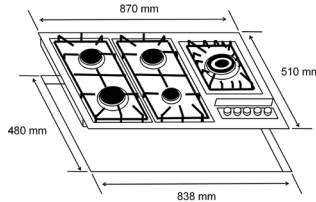

Before placing the hob in the counter cut out, the supplied foam sealing strip must be attached to the underneath of the lip of the hob. This prevents dirt and moisture from the counter top seeping under the hob.

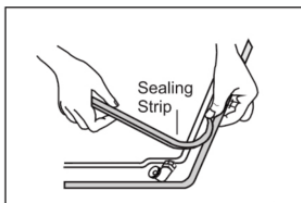

Note: This appliance is designed for use with a 2.8 kPa SANS 1237 regulator with SANS 1156-2 approved hose. Using any other type of regulator or hose is extremely dangerous.

Regulator and hose sold separately.

After installation the space under the hob must be at least 30mm.
The distance between the hob and the wall must be at least 35mm.
If an extractor hood is to be used the distance between the top of the gas hob and the bottom of the hood must be at least 650mm.

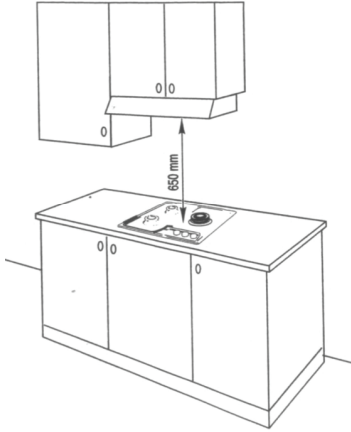

If this appliance is not being installed in a built-in structure, there should be an insulation layer between the appliances bottom and other components

LPG (Liquid Petroleum Gas) installation

- Soak the end of the gas-supply hose in hot water to soften it.
- Then push the hose end fully over the gas-supply nozzle located at the rear of the hob (see picture below).
- Secure the hose by tightening the hose clamp (see sketch below)
- Similarly, secure the other end of the hose to the regulator on the gas bottle.

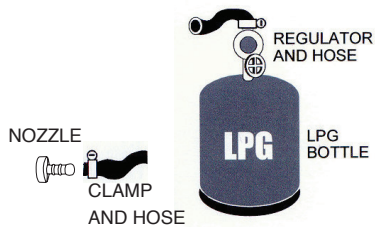

NOTE: After installing and connecting the hose to the hob and regulator, and the regulator to the gas cylinder, a gas leak test must be performed as detailed on page of the booklet.

PERMANENT INSTALLATION

The Gas Fitter must provide you with a written certificate after completion of the work. **Failure to comply with the above will render the warranty invalid.** Before the installer hands over the installed appliance be sure that you fully understand:

1. The position of the isolation or shut-off valve in the gas supply line to the hob.
2. The requirements for safe operation of the hob.

GAS:

(1) This appliance is designed for use only with LP gas

(2) Important:

Check for any leakage in your cylinder or connecting hose by using soapy water around all connections. If a flexible hose is being used, it should be of minimum length to avoid bending. Periodic checks are recommended for your own safety.

(3) Replace a Jet:

Remove the burner cap as well as the aluminium cap. Use a suitable tool to replace the jet (as indicated in picture below).

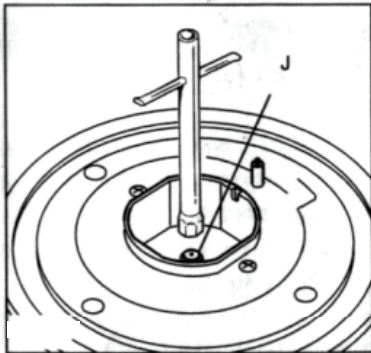

LEAK TEST

The leak test must be carried out in a well-ventilated area, free from any flames or other sources of ignition.

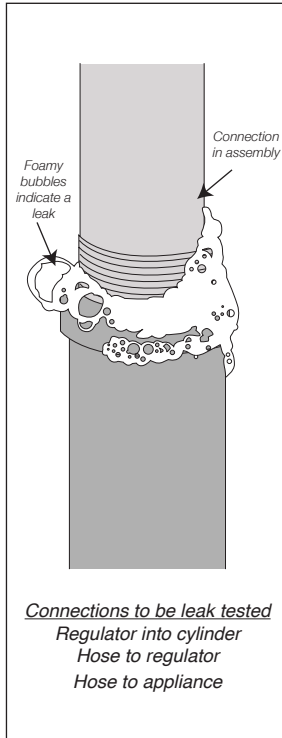

- With the cylinder connected to the hob, open the cylinder valve.
- Brush the connections (hob to cylinder) with a solution of equal parts soap and water (make sure it's foamy).
- A stream of bubbles forming indicates a gas leak. (See picture on left)
- If bubbles appear, turn the cylinder valve OFF (clockwise) and disconnect the hob from the gas cylinder.
- Tighten the connection and retry the leak test.
- If you are unsure or if you cannot tighten the connection, place the cylinder outside in a cool, well-ventilated area and contact Alva on **086 100 ALVA (2582)**.
- A leak between the hob and cylinder can lead to a high pressure fire, which is very dangerous and can result in extensive injury or even death.



PRECAUTIONS

Leak test all connections after each tank refill



NEVER check for leaks with a match or open flame

FITTING AND CHANGING THE GAS CYLINDER

1. Before connecting the appliance to a gas cylinder, always ensure that the rubber seal on the Regulator is in position and in good condition, and blow out any dust from the cylinder opening to prevent possible blockage of the jet.
2. Ensure that the gas cylinder is fitted or changed in a well-ventilated location, preferably outdoors, away from any source of ignition, such as naked flames and away from other people.



Any LP Gas cylinder not connected for use must not be stored in the vicinity of this or any other appliance.

3. Make sure that the gas cylinder is kept upright at all times, screw the regulator onto the cylinder until it is fully engaged. Hand-tighten only.
4. Never store the cylinder on the hob surface. It is best practice to store it on the floor in a position where it cannot be tampered with.
5. If there is a leak on your appliance (smell of gas), take it outside immediately into a well-ventilated flame free location where the leak may be detected and stopped.
6. When removing a gas cylinder (e.g. to change cylinders), firstly close the cylinder valve and then the appliance valve, making sure the flame is extinguished, before unscrewing the regulator. Re-fit the regulator to a full cylinder following the same precautions as above.



DO NOT store or use gasoline or other flammable vapours and liquids in the vicinity of this or any other appliance

OPERATING INSTRUCTIONS

Insert 1 x D size battery in the battery compartment. This is the power source for the automatic ignition.

Battery not provided.



AUTOMATIC IGNITION

The hob has an automatic ignition system.

1. Gently press the control knob for the selected burner and turn it anticlockwise to the highest power level. While the control-knob is held down, all the burners will generate sparks. The flame ignites.
2. Keep the control knob depressed for about 5 seconds before releasing.
3. Turn the control knob to the required position.

If the burner does not ignite, switch it off and repeat the steps described above. This time, hold the control knob down for longer (up to 10 seconds).

SWITCHING ON MANUALLY

1. Press the control knob for the selected burner and turn it anti-clockwise to the highest power setting.
2. Hold an igniter or a naked flame (such as a lighter or a match) against the burner.

WARNING - RISK OF DEFLAGRATION

If the flame does not ignite after 15 seconds, switch off the burner and open a window or the door to the room. Wait at least one minute before switching the burner on again.

NOTE: It is important to keep the appliance clean. If the ignition electrodes are dirty, this may cause ignition problems. Clean the ignition electrodes regularly with a small, non-metallic brush. Take care to prevent the ignition electrodes from sustaining any heavy knocks.

FLAME FAILURE DEVICE

Your hob is equipped with a safety system that cuts off the gas flow to the burner should the flame extinguish for any reason. To switch off the burner, turn the control knob to ● and the flame will extinguish.

An orange-coloured flame is normal. This is caused by the presence of dust in the atmosphere, split liquids, etc.

If the burner flames are accidentally blown out, switch off the burner operating control knob and do not try to relight it for at least 1 minute.

COOKING PANS

The following recommendations can help you avoid damaging your cookware:

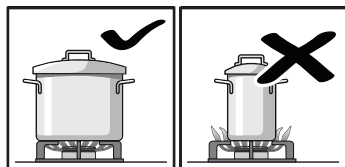

Use pans which are the right size for each burner. Do not use small pans on large burners. The flame must not touch the sides of the pan.



FOR YOUR SAFETY IF YOU SMELL GAS

- Turn off the gas supply at the cylinder.
- Extinguish all naked flames. **DO NOT** operate any electrical appliances.
- Ventilate the area.
- Check for leaks (see LEAK TEST)
- If odour persists, contact your dealer or local gas supplier immediately.

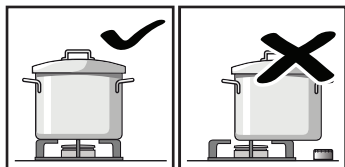

Always centre the pan over the burner, not to one side. Otherwise it could tip over. Do not place large pans on the burners near the control knobs. These may be damaged by the very high temperature.

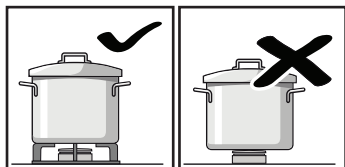

Place the pans on the pan supports, never directly on the burner. Pans should be placed on the hob carefully.

FLASHBACK (flame burns back into jet)

- If a flash back occurs (indicated by a roaring noise), immediately turn off the control knob of the affected burner.
- Close the gas cylinder valve and allow the hob to cool for a few minutes.
- Check for blockages in the burner ports. Clean with compressed air, a small soft brush or pipe cleaners.
- If the problem persists in reuse, have the hob checked by a qualified technician.

CLEANING & MAINTENANCE

GENERAL

- Allow the hob and burners to cool down completely before cleaning.
- Never use sharp instruments, abrasive cleaners, chemical sprays, steel wool, acid or chlorine based cleaners or steam cleaners on any part of the hob.
- Frequent cleaning is recommended rather than an occasional aggressive clean.

EXTERIOR

- The cast iron pan supports on the hob may be removed to allow easy access to the hob panel.



DO NOT use large pots which may overhang the body of this hob.



DO NOT use pot scourers or abrasive cleaning products on this hob as these will permanently mark the hob.

- Wash the stainless steel exterior, pan supports, removable burner caps and flame ring with hot soapy water and a sponge or soft cloth.
- Rinse and dry well.
- Acidic spills such as lemon juice, should be cleaned as soon as possible as these tend to etch into metals if left unattended.
- Routine cleaning will preserve the corrosion resistance and appearance of the stainless steel for many years.
- Clean the stainless steel as often as necessary (when noticeably dull or dirty) and use the simplest cleaning method that will effectively do the job.
- Discolouration of the stainless steel surface can occur due to high temperature.
- Never wash the flame ring, burner caps or cast iron pan supports in a dishwasher.

CONTROL PANEL

- Do not use oven cleaners, aerosols, scouring pads or abrasive cleaners.
- Wipe the control panel with a damp cloth and dry with a dry lint free cloth.
- Do not attempt to remove any of the control knobs.

IGNITION ELECTRODE & FLAME FAILURE SENSOR

- Ensure that the ignition electrode and flame failure sensor are always kept clean and the burner is fitted correctly (as indicated in picture below)

IGNITION ELECTRODE & FLAME FAILURE SENSOR

- Ensure that the ignition electrode and flame failure sensor are always kept clean and the burner is fitted correctly (as indicated in picture below)

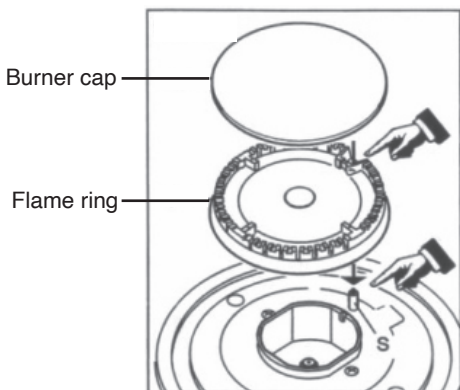

PLACE THE BURNER CAP CORRECTLY

Place the flame lid ring correctly and carefully - as indicated by the arrow. The flame ring and burner cap should not move if installed correctly (as indicated in picture below).

NOTE: Incorrect installation will cause an uneven disfigured flame, could cause the flame ring to deform and is very dangerous.

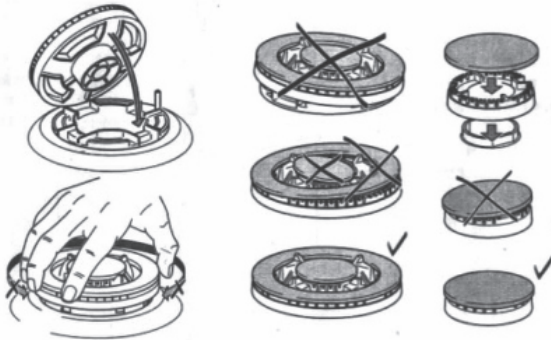

TROUBLE SHOOTING GUIDE

TROUBLE	CAUSE	REMEDY
Burner does not ignite	<ul style="list-style-type: none">• Main gas valve is closed• Hose is bent• No gas supply• Electronic ignition is wet• Battery is dead	<ul style="list-style-type: none">• Open valve• Straighten or replace hose• Replace gas cylinder• Clean and dry ignition• Replace battery

Strong gas odour	<ul style="list-style-type: none"> Gas leak from hose Hose is damaged Burner is not lit 	<ul style="list-style-type: none"> Examine hose using soap water, and replace hose . Replace it Re-ignite burner
Combustion is abnormal	<ul style="list-style-type: none"> Lack of gas supply Flame ports are clogged Burner is not in its correct position 	<ul style="list-style-type: none"> Replace gas cylinder Clean flame ports Place burner components in the right position



If you are still unable to correct the problem with the information in this guide , then you need to contact your nearest dealer or manufacturer.

SPECIFICATIONS

Model	GDH100
Description	60cm 4 Burner Gas Hob
Gas	LPG
Ignition system	Electronic ignition (PZT) 1 x D Battery
Jet Size	0.5mm x 1 - Auxiliary 0.62mm x 2 - Semi rapid 0.9mm x 1 - Wok
Rated pressure (kPa)	2.8kPa
Gas consumption at Max	73g/h - Auxiliary burner 127g/h - Semi rapid burner 240g/h - Wok burner
TO BE USED WITH A 2.8 kPa SANS 1237 APPROVED REGULATOR ONLY, WITH A MINIMUM CAPACITY OF 1kg/hr	
Any modification to the hob may cause injury or property damage.	
Any modification to the hob will invalidate the warranty on this appliance.	

Model	GDH101
Description	90cm 5 Burner Gas Hob
Gas	LPG
Ignition system	Electronic ignition (PZT) 1 x D Battery
Jet Size	0.5mm x 1 - Auxiliary burner 0.62mm x 2 - Semi rapid burner 0.72mm x 1 - Rapid burner 0.9mm x 1 - Wok burner
Rated pressure (kPa)	2.8kPa
Gas consumption at Max	73g/h - Auxiliary burner 127g/h - Semi rapid burner 204g/h - Rapid burner 240g/h - Wok burner
TO BE USED WITH A 2.8 kPa SANS 1237 APPROVED REGULATORY ONLY, WITH A MINIMUM CAPACITY OF 1kg/hr	
Any modification to the hob may cause injury or property damage.	
Any modification to the hob will invalidate the warranty on this appliance.	

AFTER SALES SERVICE

MANUFACTURED FOR AND DISTRIBUTED BY
Alva, a division of Stingray Accessory Manufacturers (Pty) Ltd.
P.O. Box 30014
Tokai, 7966
Tel: 021 442 1540
E-mail: info@stingray.co.za
www.alva.co.za
@alvagas
www.facebook.com/AlvaGas

TOLL FREE NUMBER **086 100 ALVA (2582)**



Should you experience problems with this gas hob, carry out the necessary checks as per the Trouble Shooting Guide . If you are still unable to correct the problem with the information in this guide, then you need to contact your nearest dealer or manufacturer.