

ALVA

CERAMIC ELECTRIC FAN HEATER WITH LIGHT EFFECT

EIH210

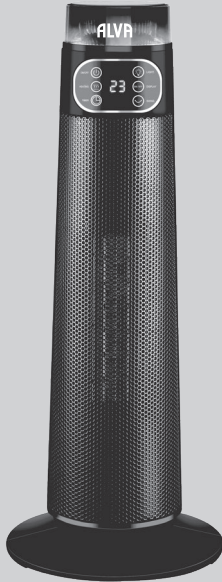

Your world is better with Alva

PLEASE READ THESE INSTRUCTIONS CAREFULLY
BEFORE USING THIS APPLIANCE AND RETAIN THIS MANUAL
FOR FUTURE REFERENCE.

As with all electrical appliances, certain care is required for safe use.
This heater is designed to operate safely and provide user comfort.

Failure to read and understand these instructions is dangerous and
can lead to property damage, injury and even death.

This appliance must not be modified in any way - doing so is not legal and will
make the appliance unsafe as well as cancel your warranty.

Manufactured for and distributed by: **ALVA** A division of Stingray Accessory Manufacturers (Pty) Ltd | P.O. Box 30014, Tokai, 7966 | +27 21 442 1540
info@stingray.co.za | www.alva.co.za | TOLL-FREE NUMBER: 086 100 ALVA (2582)

 /AlvaGas

 /alvagas

IMPORTANT SAFETY INFORMATION

As with all appliances, misuse of this appliance or failure to fully follow these instructions may cause fire, injury or death. Please read all the instructions before using your heater.

- Before using this appliance check that the voltage indicated on the type plate corresponds to your mains supply voltage.
- DO NOT use this heater with a programmer, timer or any other device that switches the heater on automatically. There is a fire risk if the heater is covered or positioned incorrectly.
- Always disconnect the heater from the electricity mains when not in use, during installation and cleaning.
- Always ensure that the power cord is kept away from the body of the heater. The heater body will get very hot while in use and can melt the cable.
- Always inspect the power cord for signs of wear or damage. If wear or damage is noted, a suitably qualified person should replace it immediately. Failing to do so is a hazard and may lead to fire and/or electrocution/electric shock and/or property damage and/or death.
- NEVER allow the cord to come into contact with wet or hot surfaces or become twisted.
- DO NOT damage and DO NOT kink the power cord.
- DO NOT use this heater if it has been dropped.
- DO NOT use if there are visible signs of damage to the heater.
- DO NOT cover or restrict airflow to the inlet or exhaust grilles in any manner as the appliance may overheat and become a fire risk (for Fan Heaters).
- DO NOT cover grilles, block entry or exhaust of airflow by placing appliance against any surface.
- DO NOT cover or obstruct the heater when in use.
- DO NOT insert any objects through any slot or opening in the heater.
- Users must not disassemble the heater, or change/substitute any parts of this heater; if the heater is faulty it is extremely dangerous to use it.
- Use this heater on a stable, horizontal surface.
- Keep the heater at a distance of at least 1 meter from any combustible material, such as furniture, curtains, bedding, clothes or paper.
- Keep the heater clean. DO NOT allow objects to enter the ventilation, as this may cause electric shock, fire or damage the heater.
- NEVER touch the appliance with wet or damp hands or feet.
- NEVER expose the appliance to atmospheric conditions (rain, sun, etc).
- DO NOT use the appliance for anything other than its intended use.
- DO NOT use this heater in the immediate surroundings of a bath, a shower or a swimming pool.



Please read the instructions carefully before use.

Retain this manual for future reference.

This appliance must not be modified in any way - doing so is illegal and will make the appliance unsafe as well as void your warranty.

- DO NOT reach for an appliance that has fallen into water. Switch off at supply and unplug immediately.
- Any repairs that need to be done to the heater must be referred to an authorized service agent only.
- DO NOT connect the appliance to multiple extension cords or multiple outlets.
- This heater is not equipped with a device to control the room temperature. DO NOT use this heater in small rooms when they are occupied by persons not capable of leaving the room on their own, unless supervised.
- This heater must not be located immediately below a socket-outlet.
- Keep away from children.
- Some parts of this product can become very hot and cause burns.
- Particular attention has to be given where children and vulnerable people are present.

Ensure that children do not play with this heater. This appliance is not intended or designed for use by persons (including children) with reduced physical, sensory or mental capabilities or lack of experience and knowledge, unless they are supervised or given instruction concerning use of this appliance by a person responsible for their safety. If the power supply cord is damaged, it must be replaced with a special cord or assembly, available from the manufacturer or its service agent.

This appliance is intended for household use only and not for commercial or industrial use.

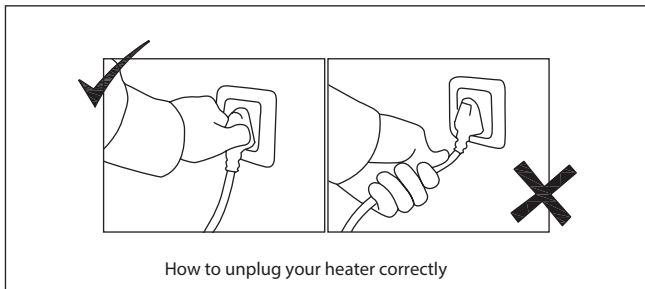

It is unsafe to mount this heater where it is close to a baffle plate or any other combustible material.

Keep combustible materials such as furniture, paper, clothes and curtains at least 1m from the front, sides and rear of the heater.

INDEX

WARRANTY	2
GENERAL INFORMATION	2
COMPONENTS	3
ASSEMBLY INSTRUCTIONS	3
REMOTE CONTROL	4
CONTROL PANEL	5
OSCILLATION BUTTON	6
TIMER BUTTON	6
CLEANING & MAINTENANCE	6
SAFETY TIP-OVER SWITCH	7
OVERHEAT PROTECTION	7
TECHINCAL DATA	7
AFTER SALES SERVICE	8

KEY



Important information



Cautions and warnings.



Danger



Contact an approved ALVA technician.



Do It Yourself

WARRANTY

PLEASE RETAIN YOUR PROOF OF PURCHASE FOR WARRANTY CLAIMS.

ALVA warrants this appliance to be free of defects in material and quality for a period of 12 months from date of original purchase. This warranty covers the intended use of this appliance – within a domestic setting and not for commercial or industrial purposes. Any damage caused by wilful abuse, tampering, modification or unauthorized repair will not be warranted.

Please retain all packaging material, as items returned without original packaging material may be subject to a withholding fee. Where this appliance is found to be defective, damaged, broken, or does not work correctly for the intended purpose, you must return the appliance to the retailer from where it was purchased. The warranty will only be effected with valid proof of purchase. Failure to provide the proof of purchase will most likely result in the repair or service required being chargeable.

If you have any questions while setting up or using this heater, please visit www.alva.co.za or call 086 100 ALVA (2582) or e-mail customercare@stingray.co.za

GENERAL INFORMATION

Before using this heater, please read through this manual and make sure you understand everything. If you are not sure, call **086 100 ALVA (2582)** or visit www.alva.co.za for help. This heater is a safe and efficient form of heating when used according to these instructions.

Reading and understanding this manual should give you a good indication of what to expect from your Alva heater. If this product is not what you want or need, please help Alva and the environment by not damaging or destroying any part of the packaging, the manual or the Styrofoam inserts.

Always keep your proof of purchase. Keep these instructions for future use. If you lose this copy, you can obtain a new copy from your dealer or online at www.alva.co.za.

ALVA

Thank you for your purchase of this heater. Please read these instructions carefully before use and keep them in a safe place, for future reference.



Not using appliances according to the instructions is extremely dangerous and can lead to property damage, injury or death.

For indoor use only.

DO NOT use within 1m of any flammable surfaces.

DO NOT store flammable materials near the heater.

COMPONENTS

COMPONENT	QTY
Heater	1
Base (Left + Right)	2
Screws	4
Remote control, 1 x CR2025 battery fitted	1

ASSEMBLY INSTRUCTIONS

1. Clip the left and right base together as in picture below.

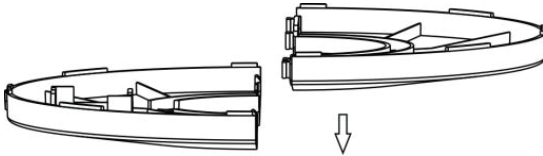

2. Place the appliance with its bottom facing upward. Position the base onto the appliance so it sits flush onto the bottom of the heater.

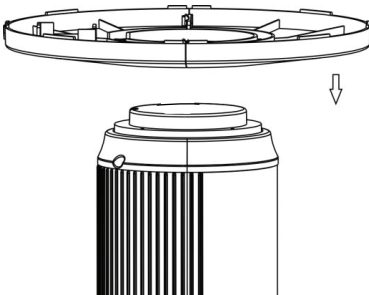

Always ensure that the heater is unplugged when not in use, installing and cleaning.



*Note:
After installing the base, check that it is properly secured and that the appliance does not wobble before use.
ONLY use the screws provided!*

- Secure the base to the appliance using 4 ST3 × 8 screws, make sure tightly fastened.

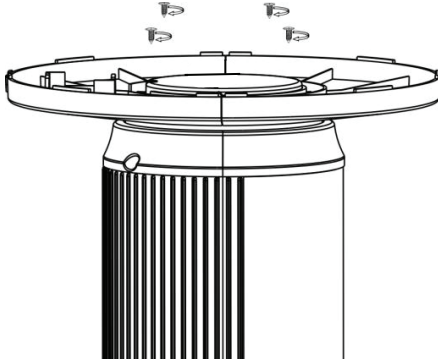

REMOTE CONTROL

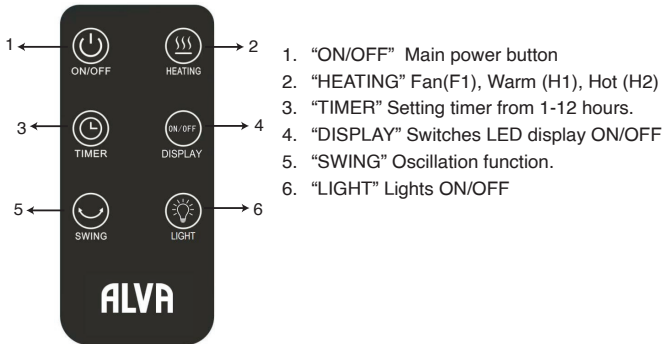

To use remote control, remove clear plastic insulation from battery compartment



Inserting batteries into the remote control

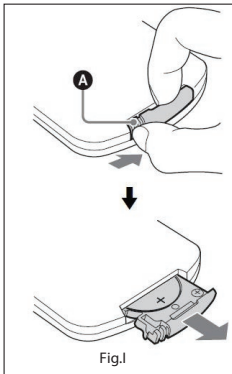

Remove the battery cover from the back of the unit and insert the battery in accordance with the polarity of the battery. (Figure 1)

Replace the old battery with the same type of battery or the heater function may be impaired.











Remove the battery before long periods of non-use to prevent leakage which will damage the remote control.



Replacement
Battery
CR2025

CONTROL PANEL



1. Before inserting the plug into an electrical outlet, make sure that the electrical supply in your area matches that on the rating label on the unit.
2. Place the heater on a firm level surface.
3. Plug the cord set into an electrical outlet. Switch on the plug and heater will be in standby mode “— —”.
4. Turn the heater ON by pressing the  button, the heater will operate as a fan. The LED displays room temperature.
5. Press heating  button for Warm (H1) setting (1000W-1200W)  heating symbol will illuminate and the heater will display room temperature.
6. Press heating  button a second time for Hot (H2) setting (2000W).
7. Press heating  button a third time for Fan (F1) setting, no heat, circulates air in room.
8. Press timer  button, you can set timer from 1-12hrs.
9. Press light  button to switch the ambient light at the top of the heater ON/OFF.
10. Press display  button to switch display LED ON/OFF.
11. Press swing  button to stop and start oscillation function.
12. After heating, when you turn off the heater by pressing  button, heating function will turn off and only fan will blow for 30s, after which the heater will switch of.

OPERATION OF THE HEATER

NOTE: It is normal, for heaters to emit some smell & fumes when they are turned on for the first time or when they are turned on after having not been used for a long period of time. This will disappear when the heater has been on a short while.



Before using the heater, make sure you understand the “IMPORTANT SAFETY INFORMATION” section of this manual.

NOTE: this is not an airconditioner. Low temperatures are relative to room temperature. This appliance only acts as a heater, it does not cool air.

OSCILLATION BUTTON

This function will work in any mode.

To switch the oscillation function on, press  button.

To stop oscillation, press the  button again.

TIMER BUTTON

This function will work in any mode. The timer function allows you to set the length of operation from 1 hour to 12 hours.

Press the  button to increase the length of operation by 1 hour each time the button is pressed. Once the timer has been set the timer will count down the hours.

The display will show automatically remaining operating time until the heater turns itself off.

Pressing the timer button once more after the display reflects 12 hours will reset the heater to continuous operation.

CLEANING & MAINTENANCE

It is necessary to periodically wipe the heater, depending on the placement and environment of its use.

Be sure the heater is fault free:

1. Check the electric mains lead is properly connected.
 2. Ensure that the mains lead and plug are not damaged.
- Your heater should be checked once a year by a qualified technician.
 - If faults are suspected or detected, stop using the heater and contact ALVA.
 - Always disconnect the heater from the electricity mains when not in use, during installation and cleaning.
 - Clean the exterior of your heater when required to remove dust.
 - A common cause of overheating is deposits of dust or fluff in the appliance. Ensure these deposits are removed regularly by vacuum-cleaning air vents and grilles, where available.
 - DO NOT use abrasive products to clean the heater; these may damage the heater surface.
 - Always make sure the heater is OFF and cool before conducting any maintenance.
 - Keep young children or infirm persons away from any hot surfaces.

- DO NOT submerge the heater in water.
- DO NOT spray down or rinse the heater with water.

SAFETY TIP-OVER SWITCH

The appliance has safety tip-over switch for safety protection. To reset, place fan heater upright on an even, stable surface and switch it back on.

OVERHEAT PROTECTION

This heater is protected with an overheat protection that switches the appliance off automatically in case of overheating. For example: due to total or partial obstruction of the vents. In this case, unplug the appliance, remove the object which is obstructing the vents, and wait about 30 minutes for it to cool. Then switch it back on as described above. The appliance should now operate normally. If the problem persists, please contact Customer Service **086 100 ALVA (2582)** or email customercare@stingray.co.za for assistance.

TECHNICAL DATA

Item number	EIH210
Voltage (V) Hz	220-240V - 50-60Hz
Electric power	2000W
Insulation protection	Class II
Heating area	15 - 20m ²

AFTER SALES SERVICE

MANUFACTURED FOR AND DISTRIBUTED BY ALVA
A division of Stingray Accessory Manufacturers (Pty) Ltd.

P.O. Box 30014, Tokai, 7966

Tel: 021 442 1540

E-mail: customercare@stingray.co.za

www.alva.co.za

 www.facebook.com/AlvaGas

TOLL FREE NUMBER

086 100 ALVA (2582)