

# ALVA

# MOJAVE

4 BURNER STAINLESS STEEL DROP-IN GAS BBQ



*Life's a Gas*

- THIS IS A LOW PRESSURE APPLIANCE TO BE USED ONLY WITH A 2.8kPa SANS 1237 APPROVED REGULATOR. (REGULATOR FITTED AND SUPPLIED)
- FOR YOUR OWN SAFETY, PLEASE READ THIS MANUAL CAREFULLY AND ALWAYS OPERATE THIS PRODUCT ACCORDING TO THE INSTRUCTIONS
- IT IS ILLEGAL AND DANGEROUS TO CHANGE OR MODIFY ANY PART OF THIS APPLIANCE



APPROVED FOR USE IN  
SOUTH AFRICA

Manufactured for  
and Distributed by:

**ALVA**  
*Life's a Gas*

ALVA Marketing (Pty) Ltd | P.O. Box 30014, Tokai, 7966 | +27 21 442 1540 | info@stingray.co.za | www.alva.co.za  
TOLL FREE NUMBER: 086 100 ALVA (2582)

 /StingrayGroupSA

 /Alvagas



## IMPORTANT SAFETY INFORMATION

- The operator is responsible for the safety of all third parties while the appliance is in use.
- The manufacturer's warranty will be voided by incorrect use of this product.
- If you have any queries regarding these instructions, contact your local dealer for clarification before you use your Gas BBQ.
- The unit must be correctly installed before use.
- DO NOT use indoors. The Gas BBQ is designed for OUTDOOR USE ONLY.
- Use only in a weather protected area, under shelter.
- Ensure that the Gas BBQ is positioned on an even and secure surface before operating.
- Ensure all gas fittings are correctly and firmly fitted before use.
- Leak test all gas lines and connections before use.
- DO NOT store flammable materials near the Gas BBQ.
- DO NOT place or use aerosol sprays near the Gas BBQ.
- Use only with LPG gas.
- DO NOT leave the Gas BBQ unattended when it is alight.
- Keep children and animals away while the Gas BBQ is in use.
- Parts of the Gas BBQ will get extremely hot and could cause serious burns - test every surface before touching it.
- The hood handle can become hot; the use of cooking gloves and the wearing of long sleeves is advised.
- Be very careful when operating the Gas BBQ. The operator should pay constant attention to the food being cooked and should remain at the appliance at all times when it is lit.
- Ensure that the gas supply is turned OFF after use and while the Gas BBQ is unattended.
- Modifying or tampering with any part of this Gas BBQ is illegal and unsafe and will void your warranty.
- DO NOT move the appliance when in use.
- The BBQ must not have any overhead obstruction. e.g. trees, shrubs and lean to roofs.
- The BBQ must be used with a clearance of 1m around the BBQ.
- Close the valve of the gas cylinder after use.
- The use of this BBQ in enclosed areas can be dangerous and is PROHIBITED.
- Neither the manufacturer nor their Agents can accept any liability for the unsuitability of, or any damage to, any food cooked on this appliance.
- Never let the cylinder stand on the ground while the BBQ is in operation. Place the cylinder in the cabinet of your BBQ.
- It is not safe to use the Gas BBQ in strong wind conditions..
- Keep onlookers a safe distance away from the Gas BBQ when it is in use.



*As with all gas appliances, misuse of this appliance or failure to fully follow these instructions may cause fire, injury or death.*

*Please read all the instructions before using your Gas BBQ.*

*The operator must understand all safety requirements as detailed in this manual before using the unit.*

*Please read the instructions carefully before use.*

*Retain this manual for future reference.*

## INDEX

WARRANTY	2
GENERAL INFORMATION	2
USE AND CHARACTERISTICS	3
INSTALLATION	3
COMPONENTS	4
ASSEMBLY INSTRUCTIONS	4-9
CONNECTING THE GAS HOSE TO THE BBQ	9
GAS CYLINDER	9
FITTING THE GAS CYLINDER TO THE APPLIANCE	9
LEAK TEST	10
REGULATOR AND HOSE	10
FIXING THE REGULATOR TO THE CYLINDER	11
LIGHTING YOUR GAS BBQ	11
MANUAL IGNITION	12
ROASTING HOOD COOKING ! VERY IMPORTANT!	12
FLARE UP CONTROL	13
FLASHBACK (FLAME IN BURNER TUBE)	13
END OF COOKING OPERATION	13-14
STORAGE	14
CLEANING AND CARE	14-16
WARNING	17
FREQUENTLY ASKED QUESTIONS	17-18
SPECIFICATIONS	18
AFTER SALES SERVICE	18
SOME GREAT RECIPE IDEAS	19-22
DESSERT ANYONE?	23-24

### KEY



*Important information*



*Cautions and warnings.*



*Danger*



*Contact an approved ALVA technician.*



*Do It Yourself*

## WARRANTY

PLEASE RETAIN YOUR PROOF OF PURCHASE FOR WARRANTY CLAIMS.

ALVA warrants this appliance to be free of defects in material and quality for a period of 12 months from date of original purchase. This warranty covers the intended use of this appliance – within a domestic setting and not for commercial or industrial purposes. Any damage caused by willful abuse, tampering, modification or unauthorized repair will not be warranted.

Please retain all packaging material, as items returned without original packaging material may be subject to a withholding fee. Where this appliance is found to be defective, damaged, broken, or does not work correctly for the intended purpose, you must return the appliance to the retailer from where it was purchased. The warranty will only be effected with valid proof of purchase. Failure to provide the proof of purchase will most likely result in the repair or service required being chargeable.

The burners and vaporisers supplied with your gas braai are considered to be consumable spares. Frequency of use, environmental factors and failing to follow the cleaning and care instructions in this manual may cause your burners and/or vaporisers to corrode. This is not considered a manufacturing fault, but rather normal wear and tear and is not covered under the warranty. Should you need to replace your burners and/or vaporisers please contact our customer care department or visit our online store [www.stingray.co.za](http://www.stingray.co.za)

Rust is not covered under the warranty.

If you have any questions while setting up or using this gas braai, please visit [www.alva.co.za](http://www.alva.co.za) or call 086 100 ALVA (2582) or e-mail [info@stingray.co.za](mailto:info@stingray.co.za)

## GENERAL INFORMATION

Before using this Gas BBQ, please read through this manual and make sure you understand everything. If you are not sure, call **086 100 ALVA (2582)** or visit [www.alva.co.za](http://www.alva.co.za) for help.

This Gas BBQ is a safe and efficient appliance when used according to these instructions.

Reading and understanding this manual should give you a good indication of what to expect from your Gas BBQ.

If this product is not what you want or need, please help Alva and the environment by not damaging or destroying any part of the packaging. Always keep your proof of purchase. Keep these instructions for future use. If you lose this copy, you can obtain a new copy from your dealer or online at [www.alva.co.za](http://www.alva.co.za).



*Thank you for your purchase of this Gas BBQ.*

*Please read these instructions carefully before use and keep them in a safe place, for future reference.*



*Failure to follow these instructions may result in serious bodily injury and/or property damage.*

*If you have any questions concerning assembly or operation, consult your local dealer.*

*DO NOT move the Gas BBQ while in operation.*

*The Gas BBQ and cylinder must be placed on a level surface.*

## USE AND CHARACTERISTICS

This BBQ is safe and easy to use. The specified gas for this BBQ is LPG. Please ensure you only use your BBQ with a 2.8kPa approved regulator. Regulator and hose supplied.

Food can be barbecued on the cooking grid either with or without the hood being closed. When the hood has been closed for 5 minutes, the hood must be opened for at least 1 minute to release heat.

The grease tray is fitted below the burners. Please clean the grease tray regularly.

Adequate ventilation is vital for combustion and efficiency performance of the BBQ. This will ensure the safety of the user and other people in the vicinity of the area where the BBQ is being used. Never use the BBQ in any enclosed covered area.

## INSTALLATION

**WARNING! THESE INSTRUCTIONS ARE FOR THE USE THE INSTALLER ONLY.**

The installer must be a registered installer with LPGSA and the installation must comply with SANS10087-2.

### SELECTING A LOCATION

This BBQ is for outdoor use only and should be placed in a well-ventilated area. This appliance consumes oxygen and it is dangerous for the health and safety of the occupants to use this appliance in areas not properly ventilated.

Take care to ensure that it is not placed near or under any combustible surface.

Keep this BBQ away from flammable materials.





Drop-in Gas BBQ dimensions (Minimum clearance of 150mm to the rear panel and 150mm to the bottom panel are necessary to ensure the air inlet and combustion products outlet openings remain unobstructed.



*Failure to follow these instructions may result in serious bodily injury and/or property damage.*

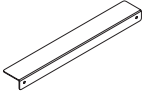
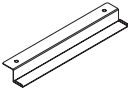
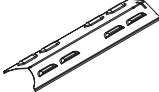
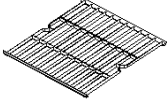
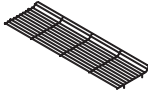
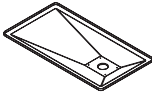
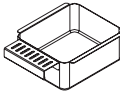

*Never use Natural Gas in a unit designed for Liquid Propane (LP) Gas. LP gas is not Natural Gas. The conversion or attempted use of Natural Gas in an LP unit is dangerous and voids your warranty.*

## COMPONENTS

<b>1.Body Assy. * 1 pc</b>	<b>2 .Mounting Bracket * 2pc</b>	<b>3. Grease Plate Rail* 2 pc</b>	<b>4.Flame Tamer* 4pc</b>	<b>5. Cooking Grate * 2 pc</b>
				
<b>6. Warming Rack* 1 pc</b>	<b>7. Drip Tray * 1 pc</b>	<b>8. Grease Box *1 pcs</b>	<b>9. Knob *4pcs</b>	<b>10. Battery *1pc</b>
				 <b>Type: AA</b>
<b>11. Control Knob Battery *4pc</b>				
 <b>Type: 11A</b>				

## ASSEMBLY INSTRUCTIONS

**NOTE:** Remove the BBQ Parts from the box before assembly. Ensure that any transit protection is removed.

<b>A. M6*16 Screw *</b> <b>8pcs</b>	<b>B. M6 Flat Washer * 8pcs</b>	<b>C. M6 Spring Washer * 8pcs</b>
		

### Step 1

Use M6x16 screw (A) x 4pcs, M6 flat washer (B) x 4pcs, M6 spring washer (C) x 4pcs, Attach the mounting brackets (2) x 2pcs as shown, onto the left and right side of the body assy (1) respectively.

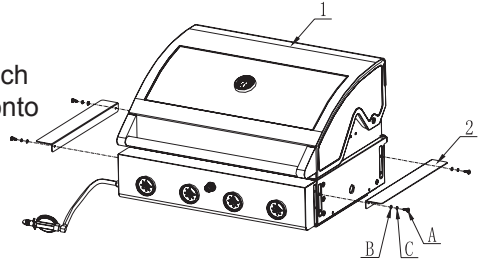

### Step 2

Use M6x16 screw (A)x 4pcs, M6 flat washer (B)x 4pcs, M6 spring washer (C)x 4pcs, Attach the grease plate rail (3) x 2pcs onto the bottom of the body assy (1) respectively.

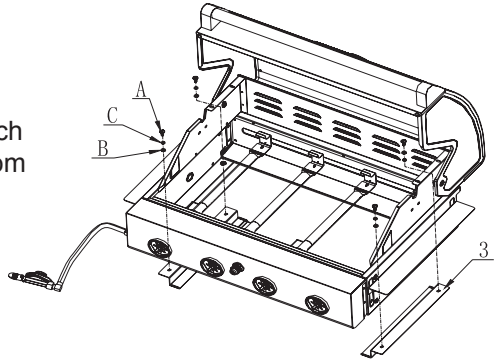

### Step 3

Attach the flame tamer (4) x 4pcs, cooking grate (5) x 2pcs warming rack (6) x 1pc, onto the body assy (1) respectively.

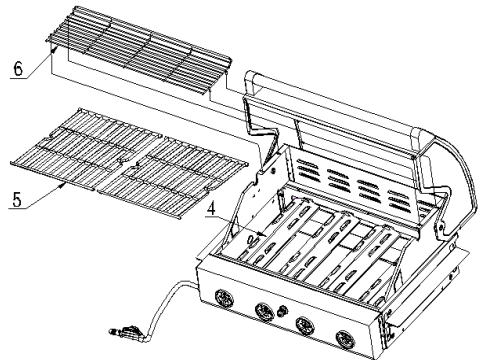



#### Step 4

Insert the drip tray (7) x 1pc into the drip tray rails beneath the body assy (1), Then put the grease cup (8) x 1pc onto the bracket which is under the grease plate.

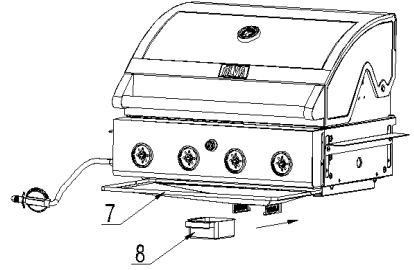

#### Step 5

Insert battery inside the rear of the control knob, Slide metal tab to one side, Place one battery (11) per cavity as indicated. Slide metal tab back over the battery. Battery Type: 11A

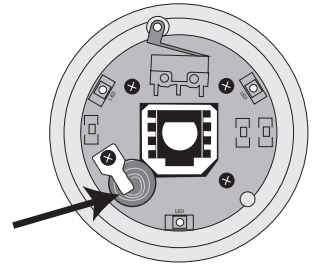

#### Step 6

Attach the knobs (9) x 4pc onto the valve of the body assy (1), then put the battery (10) x 1pc into the igniter. Battery Type: AA

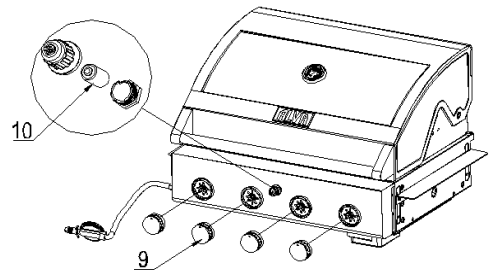

Always inspect the hose for cuts, cracks, or excessive wear before use. If the hose is damaged, it must be replaced with a hose suitable for use with LPG and which meets the national standards for the country of use (South Africa: SANS 1156-2 or EN16436). The length of the hose shall not exceed 1,5m.

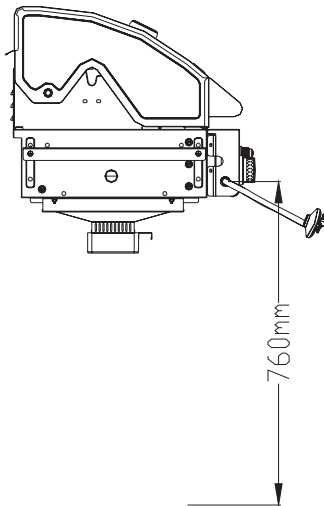
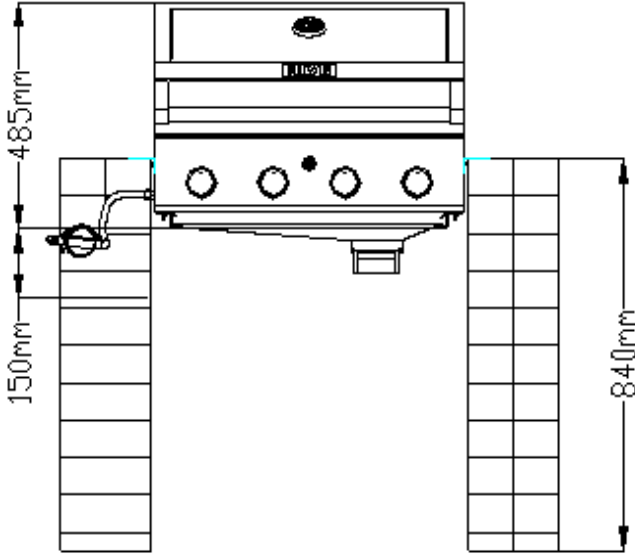

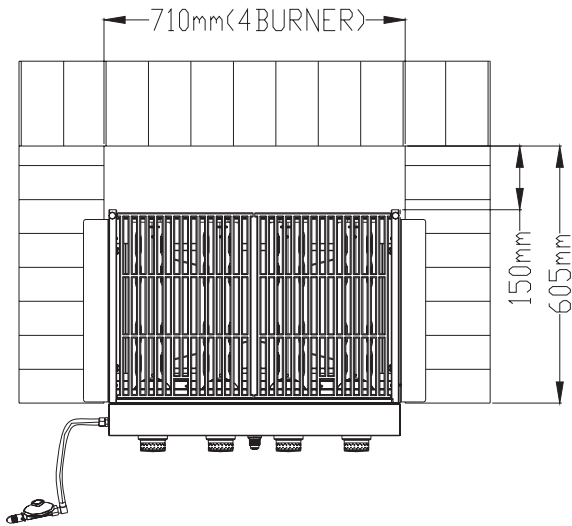

**NOTE:**

Built-in Gas BBQ Dimensions: Minimum clearance of 150mm to the rear panel and 150mm to the bottom panel are necessary to ensure the air inlet and combustion products outlets openings remain unobstructed.

**PRECAUTIONS**

Do not obstruct any ventilation opening in the BBQ body. Position the gas cylinder on a level surface in a protected environment.

If you are unclear about anything contact your installer or dealer. Should you need to change the gas cylinder, ensure that the BBQ is switched off and there are no source of ignition (eg. Cigarettes, open flames, sparks etc) nearby before proceeding. Inspect the gas hose to ensure it is free of any twisting or tension.

The hose should hang freely with no bends, folds, or kinks that could obstruct the free flow of gas. Apart from the connection point, no part of the hose should touch any hot BBQ part.

Always inspect the hose for cuts, cracks, or excessive wear before use. If the hose is damaged, it must be replaced with a hose suitable for use with LPG and which meets the national standards for the country of use.

(South Africa: SABS/SANS 1156-2 or EN 16436). The length of the hose should not exceed 1.5m.

## CONNECTING THE GAS HOSE TO THE BBQ

Connect the gas hose to the gas manifold inlet on the BBQ. Do not overtighten. Do not use any sealing tape or liquid on the connection.

## GAS CYLINDER

A 9kg ALVA gas cylinder with a 5/8 inch BSP left hand thread is recommended. This will match the supplied regulator. Cylinders must be stored in an upright position, in a well ventilated and damp free area and out of reach of children.

The cylinder must never be stored where temperatures can reach or exceed 50°C. Do not store the cylinder near open flames, pilot lights or any other sources of ignition. **DO NOT SMOKE WHILE HANDLING THE CYLINDER.**

## FITTING THE GAS CYLINDER TO THE APPLIANCE

This appliance is only suitable for use with LPG. This appliance is fitted with a 2.8kPa low pressure regulator.

**BEFORE USE PLEASE CHECK FOR LEAKS**

Never check for leaks with a naked flame, always use a soapy water solution.

1. Ensure the gas cylinder is turned off,
2. Load the cylinder into the cabinet or specified area
3. Connect the regulator to the cylinder
4. Check all the connections for gas leakage (see Leak Test on following page)



*Before proceeding make certain that you understand the **IMPORTANT INFORMATION** section of this manual*



*If any burner fails to ignite, turn the control knob off (clockwise) and also turn the cylinder valve off. Wait five minutes before attempting to relight following the correct ignition sequence from left to right.*

## LEAK TEST

The leak test must be carried out in a well-ventilated area, free from any flames or other sources of ignition.

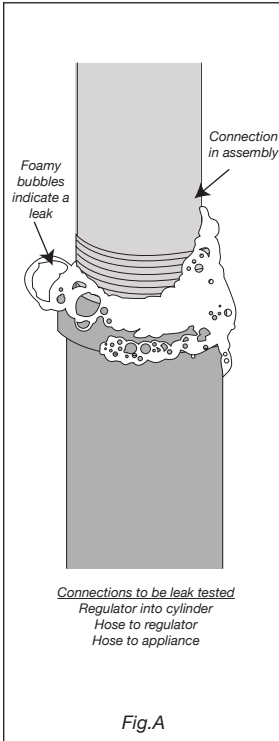

- With the cylinder connected to the Gas BBQ. Open the cylinder valve.
- Brush the connections (Gas BBQ to cylinder) with a solution of equal parts soap and water (must be foamy).
- A stream of bubbles forming indicates a gas leak. (See Fig.A)
- If bubbles appear, turn the cylinder valve OFF (clockwise) and disconnect the Gas BBQ from the gas cylinder.
- Tighten the connection and retry the leak test.
- If you are unsure or if you cannot tighten the connection, place the cylinder outside in a cool, well-ventilated area and contact Alva on **086 100 ALVA (2582)**.
- A leak between the regulator and cylinder can lead to a high pressure fire, which is very dangerous and can result in extensive injury or even death.

## REGULATOR AND HOSE

Use only regulators and hose approved for LPG in accordance to the South African National Standards. The use of the wrong regulator or hose is unsafe; always check that you have the correct items before operating the barbecue.

The length of the hose must be 1.5 meters (maximum). Worn or damaged hose must be replaced. Ensure that the hose is not obstructed, kinked, or in contact with any part of the barbecue other than at its connection. The hose should not be twisted or kinked when attached to the gas cylinder. No part of the hose should touch any part of the appliance



**FOR YOUR SAFETY  
IF YOU SMELL GAS**

- Turn off the gas supply at the bottle.
- Extinguish all naked flames. **DO NOT** operate any electrical appliances.
- Ventilate the area.
- Check for leaks (see LEAK TEST)
- If odour persists, contact your dealer or local gas supplier immediately.



**DO NOT** attempt to use the BBQ if a leak is present.

**NEVER** test for leaks with an open flame.



How to do  
a leak test



<http://www.youtube.com/watch?v=8LpZ1B0m23Y&feature=plcp>

## FIXING THE REGULATOR TO THE CYLINDER

Ensure that all the BBQ control knobs are in the OFF position. Connect the regulator to the gas cylinder according to your regulator and cylinder dealer's instructions.

Always check that the bullnose seal on the regulator is in place and in good condition before connecting the regulator to the cylinder. Perform this check every time a cylinder is connected or changed. Always make sure that the thread is fully engaged and properly tightened.

Please note that the thread on the regulator is a LEFT HAND thread and must be turned in an ANTI-CLOCKWISE direction to tighten it when facing the cylinder valve.

## LIGHTING YOUR GAS BBQ

1. The lid must be open when lighting the burners.
2. Turn all the control knobs to the OFF position.
3. Turn 'ON' the gas supply at the cylinder or regulator switch following the regulator connection and operating instructions. Check the cylinder to regulator connection and hose to barbecue hose inlet connection for leakage using soapy water. Any leakage will show as bubbles in the area of the leak. If leak is found do not use the barbecue. Consult your gas or barbecue supplier for advice.
4. To light the left hand burner, push down and turn the left burner control knob anti-clockwise to the 90° position (full rate position). Press & hold ignition button, You will hear a rapid series of "clicks" Your burner should light. If the burner has not lit, repeat this process.
5. If the burner has not lit after two attempts, turn 'OFF' the gas tap and wait 5 minutes before retrying the ignition sequence.
6. When the burner has lit, the burner rate can be adjusted by pushing down and turning the knob anti-clockwise to any position between the full and low rate position.
7. Light the remaining burners from left to right in sequence.
8. To turn 'OFF' the barbecue, turn the cylinder valve handle or regulator switch to the 'OFF' position by following the regulator instructions. Once the burners have extinguished turn all the control knobs to the 'OFF' position.

If for some reason the burner(s) do not ignite, refer to the Manual Ignition instructions that follow:

## MANUAL IGNITION

1. The lid must be open when lighting the burners.
2. Open the gas control valve at the cylinder.
3. Remove the grid. The burners will be visible. First strike a 90mm BBQ match and hold it approximately 40 mm away from the LEFT hand burner and then turn the LEFT control knob anti-clockwise to the HIGH position
4. If the burner fails to ignite after 5 seconds, turn the control knob to the OFF position and wait 2 minutes. Restart the procedure from step 2. If you fail to ignite your BBQ, turn the control knob to OFF, close your cylinder and contact your local dealer for service.
5. Light the burners in the same method, in order from left right. The burner will cross-ignite from the burner to it's left. Adjust to the required heat setting.

## ROASTING HOOD COOKING! VERY IMPORTANT!

Gas BBQ's equipped with a roasting hood give the option of cooking with the hood closed to form an 'oven' for roasting food, such as joints of meat, whole chickens, etc. When the hood is closed, a large amount of heat is trapped inside the Gas BBQ. Thus, it is important to make sure that the burner is turned to the low position to prevent burning of the food and damaging the Gas BBQ. Avoid lifting the hood unnecessarily as heat will be lost every time the hood is opened.



*IF any burner fails to ignite, turn the control knob off (clockwise) and also turn the cylinder valve off. Wait five minutes before attempting to relight following the correct ignition sequence from left to right.*



*Do not touch any hot BBQ parts. The outside of the BBQ bottom especially becomes very hot during use. Use protective gloves to handle any parts that might become hot during use.*

## FLARE UP CONTROL

Flare-ups occur when meat is barbecuing on the grill and the juices fall on the hot vaporiser/flame tamer plate and vaporise. The smoke from some flare-up helps to give the meat its BBQ flavour, but excessive flare-up will result in the meat being burned and becoming bitter. To control excessive flare-up, it is advisable to trim excessive fat from meat and poultry before grilling; to control it further, the burners can be turned to the low setting.

Finally, extinguish excessive flare-ups by applying a small amount of baking soda directly onto the vaporiser / flame tamer plate. Always protect your hands when handling anything near the BBQ cooking surface.

**DO NOT ALLOW YOUR BBQ TO OVERHEAT.**

## FLASHBACK (FLAME IN BURNER TUBE)

In the event of flash back whilst the BBQ is in use, turn all the controls and the cylinder valve to the 'OFF' position. Wait 5 minutes before attempting to relight the BBQ. If the problem persists, check for blocked ventury ports by removing the burner and cleaning with compressed air or with a pipe cleaner. Replace burner correctly.

If problem persists do not try to rectify the problem yourself as this could result in serious injury and/or property damage.

Store the appliance in a clean and dry environment. Do not store your gas cylinder indoors. Store in a well ventilated area away from direct sunlight or an electrical source.

Light the burners in the same method, in order from left right. The burner will cross-ignite from the burner to its left. Adjust to the required heat setting.

## END OF COOKING OPERATION

After each cooking session, turn the BBQ burners to the HIGH position and burn for 5 minutes. This procedure will burn off cooking residue, thus making cleaning easier. The lid must be off or the hood open during this procedure.



Turning off your BBQ.

When you have finished using your BBQ, turn off the gas at the cylinder, and then ensure that all the control valves are turned to the OFF position in sequence starting from the left hand and moving to the right hand side of the unit. Wait until the BBQ is sufficiently cool before closing its hood or lid.

## STORAGE

### FIXINGS

Annual checking and tightening of metal fixings is recommended.

### STORING YOUR BBQ

Storage of an appliance indoors is only permissible if the cylinder is disconnected and removed from the appliance.

Store your BBQ in a cool dry place. After having cleaned the burners, cover them with aluminium foil in order to prevent insects and other debris collecting in burner holes.

THE GAS CYLINDER SHOULD BE DISCONNECTED AND STORED OUTDOORS OR IN A WELL VENTILATED AREA.

When using the barbecue after extended periods of storage, please take note once again of the care, maintenance and safety instructions.

## CLEANING AND CARE

As with all appliances, proper care and maintenance will keep them in top operating condition and prolong their life. Your new gas BBQ is no exception. By following these cleaning procedures on a regular basis, your BBQ will remain clean and in good working order with the minimum of effort.

** BEWARE OF SPIDERS AND WASPS. BURNER TUBES SHOULD BE INSPECTED AND CLEANED PERIODICALLY!**

Spiders and small insects occasionally spin webs or make nests in the burner tubes during warehousing and transit. These webs can lead to a gas flow obstruction which could result in a fire in and around the burner tubes.

### STAINLESS STEEL CARE

In order to preserve the stainless steel on your BBQ, we suggest applying a thin film of baby oil to the stainless steel body components of your BBQ on a regular basis. This is especially important at the coast.

Once applied, you can wipe all excess baby oil residue off with a clean cloth.

**NEVER USE OVEN CLEANER**

Failure to follow these instructions may cause the BBQ to rust

This type of fire is known as FLASH-BACK and can cause serious damage to your BBQ and create an unsafe operating environment for the user. Although an obstructed burner tube is not the only cause of FLASH-BACK it is the most common cause and frequent inspection and cleaning of the burner tubes is necessary.

To reduce the chance of FLASH-BACK, the procedure listed below should be followed at least once a month in late summer or early autumn when spiders are most active, or when your BBQ has not been used for an extended period of time.

### BURNER TUBE CLEANING

Follow the procedure that is most convenient for you:

1. Use a small bottle brush with a flexible handle. Run the brush up through each venturi tube and into the burner several times.
2. Lay the burners down with the venturi tubes facing up, and force water through them. At this time, observe each burner port. Make sure water comes out of every hole. If not, clean the burners as follows

### BURNER CLEANING

Regardless of which venturi cleaning procedure you used, we recommend that you complete the following steps to help prolong burner life.

1. Scrub the entire outer surface of the burner with a non-metallic scouring pad to remove any loose corrosion.
2. Clean any clogged holes with a stiff piece of wire (for example: an open paper clip).
3. Inspect the burner assembly for any opening caused by corrosion.
4. If any openings due to corrosion are found, replace the burner.
5. Replace the burner and spring as described in the assembly instructions.
6. Check the burner for proper location/seating after replacement.
7. Ensure that the valve orifices are inside the burner tube.

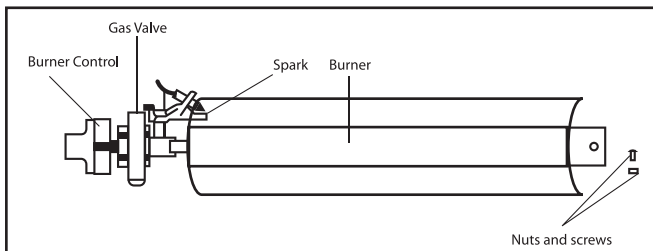

*All cleaning and maintenance should be carried out when the BBQ is cool and with the gas supply turned OFF at the gas cylinder.*



*Never attempt to operate your barbecue without the burner tube being correctly located. A serious and immediate fire hazard would result.*



**VERY IMPORTANT**  
*The location of burner with respect to the orifice is vital to safe operation. Check to ensure the valve orifices are inside of the burner tubes before using your gas BBQ (See Rotary piezo ignitor diagram). If the burner tubes (venturi) are not fitted over the valve orifices and you start lighting the burners, an explosion and fire might occur.*

## CLEANING THE GRIDS

After cooking, turn the burner control to “OFF” and let the BBQ cool before attempting to clean your grill plates. Before first use - as well as periodically - we suggest that you wash the grids in a mild soap and warm water solution. You can use a wash cloth, a vegetable brush, or non-metallic scouring pad to clean your grids.

The drip tray should be emptied and wiped down periodically and washed in a mild detergent and warm water solution.

A level layer of clean dry sand should be placed in the bottom of the sand tray to absorb the grease.

Lining the tray with aluminium foil before use will aid in cleaning.

## ANNUAL CLEANING OF BBQ HOUSING

Burning-off the grill after cooking will keep it ready for instant use, however, once a year you should give the entire BBQ a thorough cleaning to keep it in top operating condition.

1. Turn the burner controls to the “OFF” position.
2. Turn the cylinder valve off fully.
3. Detach the regulator assembly from cylinder valve by turning the quick coupling nut.
4. Remove and clean (as explained above) the grids, flame tamer and burners.
5. Cover the gas valve orifices with aluminium foil.
6. Brush the inside and bottom of the BBQ with a cleaning brush, and wash down with a mild soap and warm water solution. Rinse thoroughly and let dry.
7. Remove aluminium foil from orifices and check orifices for obstruction.
8. Check spark electrode, adjusting it as instructed. Electrode tip pointing toward the tip of gas collector and approximately 5 mm from the tip of collector box.
9. Replace burners. Adjust spark electrode collector box.
10. Replace flame tamer, grids and warming rack.
11. Re-connect to gas supply.

## VISUALLY CHECKING BURNER FLAMES

**Occasionally observe burner flame for correct operation.**

**See diagram below.**

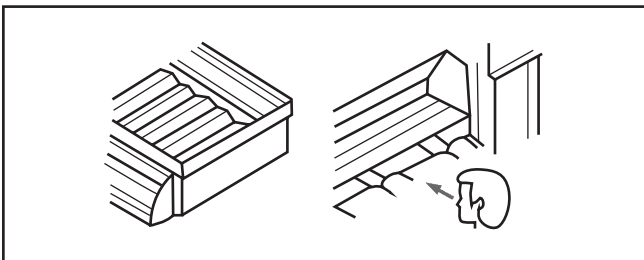

## WARNING

- The appliance is designed for outdoor use only.
- **WARNING!** Accessible parts may be very hot. Keep young children away.
- Read the instructions before using the appliance.
- Do not move the appliance while in use.
- Turn off the appliance at the cylinder valve after use.
- The Gas BBQ must not have any overhead obstructions e.g. trees, shrubs and lean to roofs.
- The Gas BBQ must be used with a clearance of 1m.
- The Gas BBQ must not be used near flammable materials (petroleum based products, thinners or any other solid object that carries a flammable warning label).
- Close the valve of the gas cylinder after use.
- The use of this Gas BBQ in enclosed areas can be dangerous and is **PROHIBITED**
- It is illegal and dangerous to change or modify any part of this appliance:
- The warranty will be voided against any and all claims if the unit has:
  - a. Not been assembled and operated in accordance with the instructions provided
  - b. Been used for commercial purposes
  - c. Been abused, misused or left exposed to the elements
  - d. Been damaged as a result of a fat fire
  - e. Any repairs, modifications or tampering, with this appliance by an unauthorised person is not allowed and will nullify the warranty.
  - f. Claim relates to rust.



*For use outdoors only and in well ventilated areas*

*WARNING: Accessible parts may be very hot, keep young children away*

*Read the instructions before using the appliance.*

*DO NOT move the appliance while in use.*

## FREQUENTLY ASKED QUESTIONS

**Q:** How long will the gas in my cylinder last?

**A:** This depends on how you use your BBQ. It is easy to calculate your gas consumption. Take the capacity of the gas cylinder in grams (i.e. 9000g for a 9kg cylinder) and divide it by the gas consumption of the appliances. The answer to the calculation is the approximate number of hours that your gas will last for.

**Q:** What do I do if I have an over-filled cylinder?

**A:** The best method to determine if your cylinder is over-filled is to weigh it. Subtract the 'tare' mass from the cylinder weight – this gives you the weight of your gas. If this gas weight exceeds your cylinder design weight (9kg) then return the cylinder to your gas supplier.

- Q: Can I use a rotisserie on the BBQ?**  
**A:** Yes, Alva has a rottisseries code: GA67 available and custom designed for use with this BBQ.

## SPECIFICATIONS

Model	GSS4BTT
Description	4 Burner Gas BBQ
Gas Consumption at max	1020gr/hr
Type of Gas	LPG
Operating pressure	2.8kPa
<p>FOR USE OUTDOORS ONLY AND IN WELL VENTILATED AREAS. TO BE USED WITH A 2.8kPa SANS 1237 APPROVED REGULATOR WITH A MINIMUM DELIVERY CAPACITY OF 1kg/h WITH A SANS 1156-2 OR EN 16436 APPROVED HOSE. REGULATOR AND HOSE SUPPLIED.</p>	
<p>WARNING: ACCESSIBLE PARTS MAY BE VERY HOT. KEEP YOUNG CHILDREN AWAY.</p>	
<p>READ THE INSTRUCTION LITERATURE BEFORE USING THE APPLIANCE. DO NOT MOVE THE APPLIANCE WHILE IN USE.</p>	

## AFTER SALES SERVICE

MANUFACTURED FOR AND DISTRIBUTED BY  
 Alva Marketing (Pty) Ltd  
 P.O. Box 30014  
 Tokai, 7966  
 Tel: 021 442 1540  
 E-mail: info@stingray.co.za  
 www.alva.co.za  
 @StingrayGroupSA  
 www.facebook.com/AlvaGas

TOLL FREE NUMBER **086 100 ALVA (2582)**

\***SPARES** are available from our online store  
 www.stingray.co.za

*How to test if  
 your cylinder  
 is overfilled*



*<http://www.youtube.com/watch?v=YavsYE8nzCw&feature=plcp>*

## SOME GREAT RECIPE IDEAS

### NEVER FAIL BBQ SAUCE



<i>2Tbsp</i>	<i>Butter or Margarine</i>
<i>1 Clove</i>	<i>Garlic (Finely Chopped)</i>
<i>¼ cup</i>	<i>Finely Chopped onion</i>
<i>1 cup</i>	<i>Tomato Juice</i>
<i>½ tsp</i>	<i>Ground Ginger</i>
<i>¼ cup</i>	<i>Lemon Juice</i>
<i>1 tsp</i>	<i>Prepared mustard</i>
<i>1 Tbsp</i>	<i>Worcestershire sauce</i>
<i>¼ cup</i>	<i>Brown sugar, firmly packed</i>
<i>¼ tsp</i>	<i>Hot pepper sauce</i>

#### Method:

Cook onion, garlic and margarine in a saucepan, until onion is clear. Add the remaining ingredients and bring to the boil. Simmer uncovered for 15-20 minutes. Refrigerate left overs after use.

### MARINATED CHICKEN



<i>¼ cup</i>	<i>Dijon mustard</i>
<i>1 tsp</i>	<i>Dried Tarragon</i>
<i>2 Tbsp</i>	<i>Fresh lemon juice</i>
<i>¼ tsp</i>	<i>Freshly ground black pepper</i>
<i>1½ tsp</i>	<i>Worcestershire sauce</i>
<i>4</i>	<i>Boneless, skinless Chicken Breast halves</i>

#### Method:

Combine all ingredients and mix well. Marinate the chicken breasts for several hours. Grill the chicken, uncovered, over a medium heat for 10-15 minutes. The chicken is done once the juices run clear and the chicken has turned white.

## BARBEQUED HONEY STEAK



<i>2kg</i>	<i>Beef sirloin steak</i>
<i>2</i>	<i>Garlic Cloves, crushed</i>
<i>2 Tbsp</i>	<i>Red pepper, crushed</i>
<i>1</i>	<i>Large onion, chopped</i>
<i>1 tsp</i>	<i>Black pepper</i>
<i>1 cup</i>	<i>Honey</i>

### Method:

Combine all ingredients well and marinate the steak for 7-8 hours.

Remove the steak from the marinade and grill over a very high heat until cooked as desired.

Bring the left over marinade to the boil and pour over the grilled steak.

## GRILLED VEGGIES



<i>¾ cup</i>	<i>Olive oil</i>
<i>1 tsp</i>	<i>Fresh Oregano, chopped</i>
<i>¼ cup</i>	<i>Red wine vinegar</i>
<i>1 Tbsp</i>	<i>Crushed Garlic</i>
<i>1 tsp</i>	<i>Fresh Rosemary</i>
<i>½ tsp</i>	<i>Salt</i>
<i>1 tsp</i>	<i>Fresh Thyme leaves</i>
<i>½ tsp</i>	<i>Ground black pepper</i>
<i>1 tsp</i>	<i>Fresh Basil, chopped</i>
<i>1 kg</i>	<i>Assorted vegetables, chopped or whole</i>

### Method:

Combine all the ingredients in a bowl.

Refrigerate the marinated vegetables for 2 hours.

Grill the vegetables over a medium heat until tender, brushing with marinade as they cook.

Cooking time will vary according to the size and variety of vegetables that you use.

## GRILLED BOEREWORS/SAUSAGE



*Boerewors (as much as desired)*

*Olive oil*



Prepare the boerewors/sausage with the BBQ hood open.

### Method:

Brush the boerewors/sausage and grill lightly with Olive oil.

Preheat the grill. Turn the heat down to low and place the boerewors/sausage on the grill.

Grill on one side for  $\pm 5$  minutes, before turning over and leaving for another  $\pm 5$  minutes. Cooking times will vary depending on the thickness of the boerewors/sausage.

## GRILLED RUMP STEAK



*Rump Steaks (Each  $\pm 20$ mm thick)*

*Olive oil*

*Seasoning of choice*

### Method:

Brush the rump steaks with olive oil.

Leave the steaks out of the refrigerator for 3-4 hours, to reach room temperature.

Brush the grill lightly with oil.

Preheat the BBQ on high with the lid open for 3-5 minutes.

Place the steak on the grill:

$\pm 3$  minutes on one side (stop here for a rare steak) and then turn the steak over and leave for another 3 minutes (stop here for a medium rare steak). Add your seasoning of choice.

Turn the BBQ off and leave for  $\pm 1-2$  minutes with a closed lid (your steak is now well done).



## PRAWNS A LA ALVA



5	<i>King or Tiger prawns, unpeeled</i>
6	<i>Garlic Cloves, crushed</i>
100ml	<i>Olive oil</i>
1 Tbsp	<i>Fresh Sage, chopped</i>
100ml	<i>Basil oil</i>
20g	<i>Salt</i>
	<i>20 drops Tobasco Sauce</i>

### Method:

Combine all the ingredients, except the prawns, to create a marinade.

Marinate the unpeeled prawns for several hours in advance.

Grill the marinated prawns till they turn pink and their tails curl.

## RIB EYE STEAKS WITH GRILLED VEGETABLES AND OLIVE BUTTER



4	<i>Rib Eye Steaks</i>
	<i>An assortment of vegetables</i>
<i>For the olive butter:</i>	
250g	<i>Butter (room temperature)</i>
10	<i>Sundried Tomatoes</i>
10	<i>Black olives, Finely chopped</i>
10g	<i>Ground Paprika</i>
5	<i>Garlic cloves, Crushed</i>
2tsp	<i>Fresh Basil</i>
	<i>Salt and Pepper to taste</i>

### Method:

Combine all the olive butter ingredients.

Once combined, roll the olive butter into 'sausage' shape in aluminium foil and allow to firm in the fridge or place in the freezer for a short period of time.

Season the meat with herbs of your choice and grill for 5 minutes at a high temperature. Remove the steaks from the grill and leave them in a warm dish.

While the steak warms, grill the vegetables (Carrots, cauliflower, fennel, artichokes, corn on the cob, asparagus and celery are good options). Hard vegetables should preferably be parboiled first in water or stock. Brush the vegetables with meat marinade and herb oil before grilling. Season the vegetables with more BBQ herbs and cook for around 5 minutes over a lower heat.

Dot the meat with 2 or 3 slices of the olive butter and serve with the grilled vegetables.

## DESSERT ANYONE?

### CINNAMON APPLES



4	<i>Medium tart apples, cored</i>
4 tsp	<i>Cinnamon</i>
4 tsp	<i>Brown sugar</i>
	<i>Vanilla ice-cream or custard (optional)</i>

#### Method:

Mix the cinnamon and sugar together.

Place each apple in the centre of a piece of heavy duty foil ( $\pm 30$  cm square). Spoon 1 teaspoon of the sugar and cinnamon mix into the centre of each apple. Fold the foil around the apple and seal it tightly. Grill the apples, covered, over a medium-hot heat for  $\pm 30$  minutes or until the apples are tender. Carefully transfer the apples and syrup into bowls. Serve warm with custard or ice-cream.

### SUMMER MEDLEY



1 cup	<i>Fresh Blueberries</i>
2 tbsp	<i>Butter or Margarine</i>
1 Tbsp	<i>Fresh lemon juice</i>
1 Tbsp	<i>Brown Sugar</i>
3	<i>Medium peaches, halved and pitted</i>

#### Method:

Place each peach half, cut side up, on a double layer of heavy duty foil ( $\pm 30$  cm square).

Sprinkle the peach with about 2 tablespoons of blueberries, 1 teaspoon brown sugar, 1 teaspoon butter and  $\frac{1}{2}$  teaspoon lemon juice. Fold the foil around the peaches and seal tightly.

Grill the peaches, covered, over a medium-low heat for 18-20 minutes or until the peaches are tender.



*For a little something extra, add chopped nuts and raisins as well as the sugar and cinnamon mix to the foil parcel before grilling.*



*Serve with a sprinkling of icing sugar and a fresh mint leaves for a beautiful presentation.*

*Serve with fresh cream or ice cream.*

## MEXICAN SMORES



<i>½ cup</i>	<i>Creamy Peanut butter</i>
<i>½ cup</i>	<i>Semi-sweet chocolate chips</i>
<i>4</i>	<i>Flour tortillas (20cm)</i>
<i>1</i>	<i>cup Miniature marshmallows</i>
	<i>Vanilla ice-cream</i>

### Method:

Spread 2 tablespoons of peanut butter on each tortilla. Sprinkle a ¼ marshmallows and 2 tablespoons chocolate chips on half of each tortilla. Roll each tortilla up, beginning with the topping side. Wrap each rolled tortilla in heavy duty foil and seal tightly. Grill, covered, over a low heat for 5-10 minutes or until heated through. Unwrap the tortillas and place on dessert plates. Serve with ice-cream.



Try using a mix of semi-sweet chocolate chips and broken chilli chocolate for a little more spice.