



# ALVA

## LUXURIOUS INFRARED GAS HEATER

GH312 • GH320 • GH321



Your world is better with Alva

- THIS IS A LOW PRESSURE APPLIANCE TO BE USED ONLY WITH A 2.8kPa SANS 1237 APPROVED REGULATOR & SANS 1156-2 HOSE (REGULATOR & HOSE FITTED & SUPPLIED)
- FOR YOUR OWN SAFETY, PLEASE READ THIS MANUAL CAREFULLY AND ALWAYS OPERATE THIS PRODUCT ACCORDING TO THE INSTRUCTIONS
- IT IS ILLEGAL AND DANGEROUS TO CHANGE OR MODIFY ANY PART OF THIS APPLIANCE



APPROVED FOR USE IN  
SOUTH AFRICA

Manufactured for  
and distributed by:



**ALVA**  
Your world is better with Alva

A division of Stingray Accessory Manufacturers (Pty) Ltd | P.O. Box 30014, Tokai, 7966  
+27 21 442 1540 | info@stingray.co.za | www.alva.co.za  
TOLL FREE NUMBER: 086 100 ALVA (2582)

 /AlvaGas

 /alvagas

## IMPORTANT SAFETY INFORMATION

As with all gas appliances, misuse of this appliance or failure to fully follow these instructions may cause fire, injury or death. Please read all the instructions before using your gas heater.

- THIS UNIT MUST BE THOROUGHLY CHECKED BEFORE USE.
- Ensure that all the gas fittings are correctly and firmly fitted before every use.
- DO NOT use this heater if you do not clearly understand the instructions and/or how to operate the controls.
- Phone the customer care line at 086 100 ALVA (2582) or email [info@stingray.co.za](mailto:info@stingray.co.za) for assistance.
- DO NOT use this heater in an enclosed area, which could restrict airflow, as this is a flue-less heater (It does not have a fixed chimney). Always make sure there is enough fresh air entering the room, by opening a door or window in the same room.
- DO NOT operate this heater in a bedroom, caravan, boat or any area less than 80 cubic meters(roughly 5 x 5 metres).
- DO NOT leave the heater unattended while in use.
- Ensure that the gas supply is turned OFF after use and while the heater is unattended.
- DO NOT move the heater while in use.
- DO NOT place objects on or against the heater.
- DO NOT attempt to use the heater as a stove.
- DO NOT use a naked flame to test for leaks. Follow the Leak Testing procedure outlined under 'LEAK TEST'.
- NEVER use this heater with a cylinder other than the size recommended
- DO NOT touch the dress guard (front wire grill), as it gets very hot, while in use or after it has been switched off and is cooling. The dress guard does not give protection. No part of the dress guard should be removed or changed.
- DO NOT unscrew the regulator while the heater is on or if the cylinder valve is open.
- DO NOT use a heater you suspect is faulty.
- When turning the heater off, first turn the gas off at the control valve (on the heater) and then make sure to close the cylinder valve.
- For safety reasons, only a qualified technician may execute maintenance and repairs. The guarantee for the heater will be rendered void if the heater is serviced or repaired by any one other than an Alva appointed technician.
- The heater should be inspected once a year by a qualified technician, to make sure the unit is safe and fault free.
- The operator is responsible for the safety of all third parties while the heater is in use.



*Please read the instructions carefully before use.*

*Retain this manual for future reference.*

*DO NOT place the heater near walls, curtains or furniture while in use. The heater should always face the centre of the room, as indicated below.*

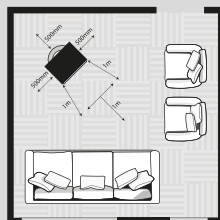

*The recommended positioning of a gas heater in any living environment. Always have a clearance of at least 500mm on the sides and back and  $\pm 1000\text{mm}$  (1m) in front of it.*

## INDEX

WARRANTY	2
GENERAL INFORMATION	2
METHOD OF ASSEMBLY (USE WITH PARTS LIST)	3
HEATER SET UP	3
LEAK TEST	5
FLASHBACK (flames in the burner tube)	5
EXPLODED VIEW	6
ASSEMBLY INSTRUCTIONS	8
USING YOUR HEATER	9
CHANGING YOUR CYLINDER	10
MAINTENANCE	11
FREQUENTLY ASKED QUESTIONS	11
SPECIFICATIONS	13
TROUBLESHOOTING GUIDE	13
FEATURES	14
AFTER SALES SERVICE	14

### KEY



*Important information*



*Cautions and warnings.*



*Danger*



*Instructional video available*

## WARRANTY

PLEASE RETAIN YOUR PROOF OF PURCHASE FOR WARRANTY CLAIMS.

ALVA warrants this appliance to be free defects in material and quality for a period of 24 months from date of original purchase. This warranty covers the intended use of this appliance – within a domestic setting and not for commercial or industrial purposes. Any damage caused by willful abuse, tampering, modification or unauthorized repair will not be warranted.

Please retain all packaging material, as items returned without original packaging material may be subject to a withholding fee. Where this appliance is found to be defective, damaged, broken, or does not work correctly for the intended purpose, you must return the appliance to the retailer from where it was purchased. The warranty will only be effected with valid proof of purchase. Failure to provide the proof of purchase will most likely result in the repair or service required being chargeable.

If you have any questions while setting up or using this heater, please visit [www.alva.co.za](http://www.alva.co.za) or call 086 100 ALVA (2582) or e-mail [info@stingray.co.za](mailto:info@stingray.co.za)

## GENERAL INFORMATION

Before using this heater, please read through this manual and make sure you understand everything. If you are not sure, please call 086 100 2582 or visit [www.alva.co.za](http://www.alva.co.za) for help. This heater is a safe and efficient form of heating when used according to these instructions.

Reading and understanding this manual should give you a good indication of what to expect from your Alva gas heater.

If this product is not what you want or need, please help Alva and the environment by not damaging or destroying any part of the packaging, the manual or the Styrofoam inserts. Always keep your proof of purchase.

Keep these instructions for future use. If you lose this copy, you can obtain a new copy from your dealer or online at [www.alva.co.za](http://www.alva.co.za)



*Thank you for your purchase of this instant infrared heater. Please read these instructions carefully before use and keep them in a safe place, for future reference.*



*Not using gas and/or gas appliances according to the instructions is extremely dangerous and can lead to property damage, injury or death.*

## METHOD OF ASSEMBLY (USE WITH PARTS LIST)

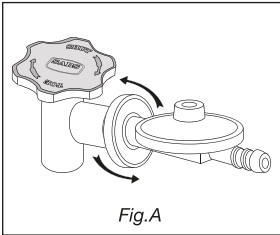

This heater makes use of an industrial cylinder (9kg ALVA cylinder recommended) with a 5/8" BSP thread; horizontal exit valve. The Bullnose regulator supplied with the heater tightens to the left hand side (anti-clockwise). (Figure A)

If you have bought a new gas cylinder, the cylinder needs to be purged (cleared out), before it's first use. If it is not purged of air, the heater will not work properly. This should happen at the gas filling station when you fill up the cylinder. Always check this with your gas supplier.

## HEATER SET UP

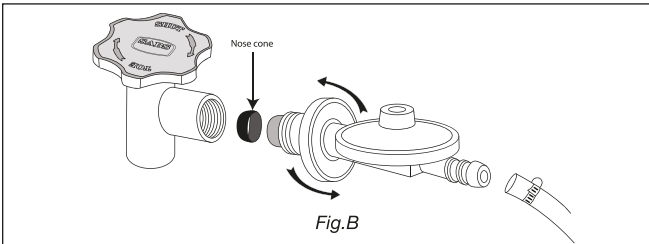

1. Before removing this heater from the packaging, read this manual in full and make sure that it is what you want /need.
2. Remove the heater from the packaging.
3. Check if the nose cone is present, secure and in good condition. (Figure B)



### WARNING

*This heater operates directly on an industrial cylinder with a 5/8" HORIZONTAL exit valve. (ALVA 9kg industrial size)*

*It is NOT to be used on a domestic cylinder with a 3/8" VERTICAL exit valve.*

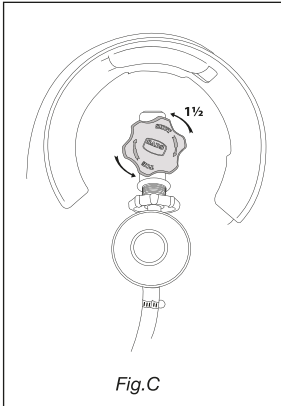

Fig.C

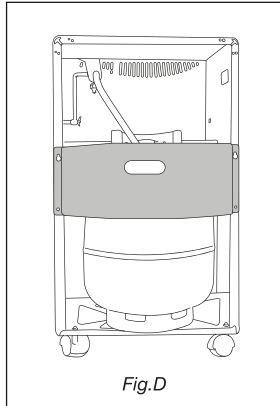

Fig.D

1. The regulator goes directly into the cylinder valve. Always make sure the regulator is pushed fully to the bottom of the cylinder valve before tightening. The use of any adaptor is illegal.
2. Screw the regulator into the cylinder valve. DO NOT use a tool to tighten the regulator; it is to be hand-tightened only.
3. Open the control valve 1½ turns to the left (anti-clockwise). (Figure C)
4. Push the control knob down for at least 10 seconds, but DO NOT try to ignite the heater. This will allow gas to flow through the heater, making the leak test possible.
5. DO THE LEAK TEST (page 5)
6. Place the cylinder in the heater cabinet by securing the rear guard in place. (Figure D)

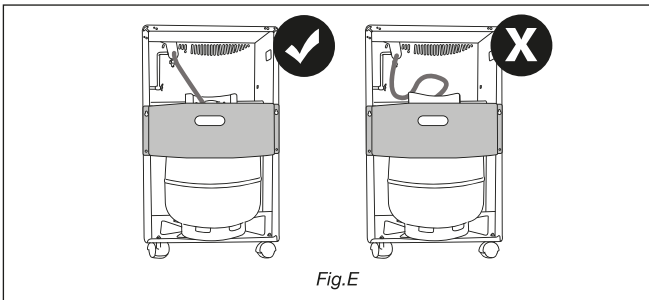
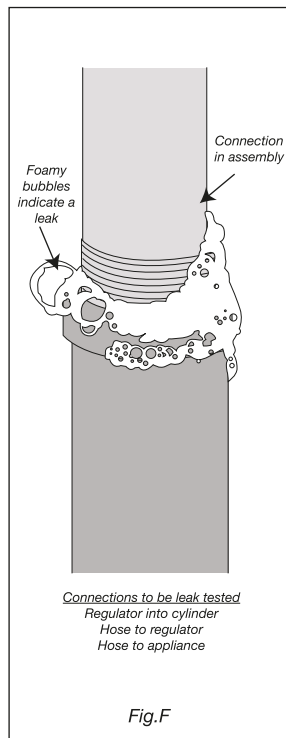

Fig.E

## LEAK TEST

The leak test must be carried out in a well-ventilated area, free from any flames or other sources of ignition.



- With the cylinder connected to the heater. Open the cylinder valve.
- Brush the connections (heater to cylinder) with a solution of equal parts soap and water (make sure it's foamy).
- A stream of bubbles forming indicates a gas leak. (See Fig.F)
- If bubbles appear, turn the cylinder valve OFF (clockwise) and disconnect the heater from the gas cylinder.
- Tighten the connection and retry the leak test.
- If you are unsure or if you cannot tighten the connection, place the cylinder outside in a cool, well-ventilated area and contact Alva on **086 100 ALVA (2582)**.
- A leak between the heater and cylinder can lead to a high pressure fire, which is very dangerous and can result in extensive injury or even death.

## FLASHBACK (flames in the burner tube)

- If a flash back occurs (indicated by a roaring noise), immediately close the cylinder valve.
- Turn the heater OFF at the control knob.
- Disconnect the regulator and allow the heater to cool.
- Check for blockages in the venturi ports. Clean with compressed air, a small soft brush or pipe cleaners.
- If the problem persists in reuse, have the heater checked by a qualified technician.

How to do  
a leak test



<http://www.youtube.com/watch?v=8LpZ1B0m23Y&feature=plcp>



**FOR YOUR SAFETY  
IF YOU SMELL GAS**

- Turn off the gas supply at the bottle.
- Extinguish all naked flames. **DO NOT** operate any electrical appliances.
- Ventilate the area.
- Check for leaks (see LEAK TEST)
- If odour persists, contact your dealer or local gas supplier immediately.

EXPLODED VIEW

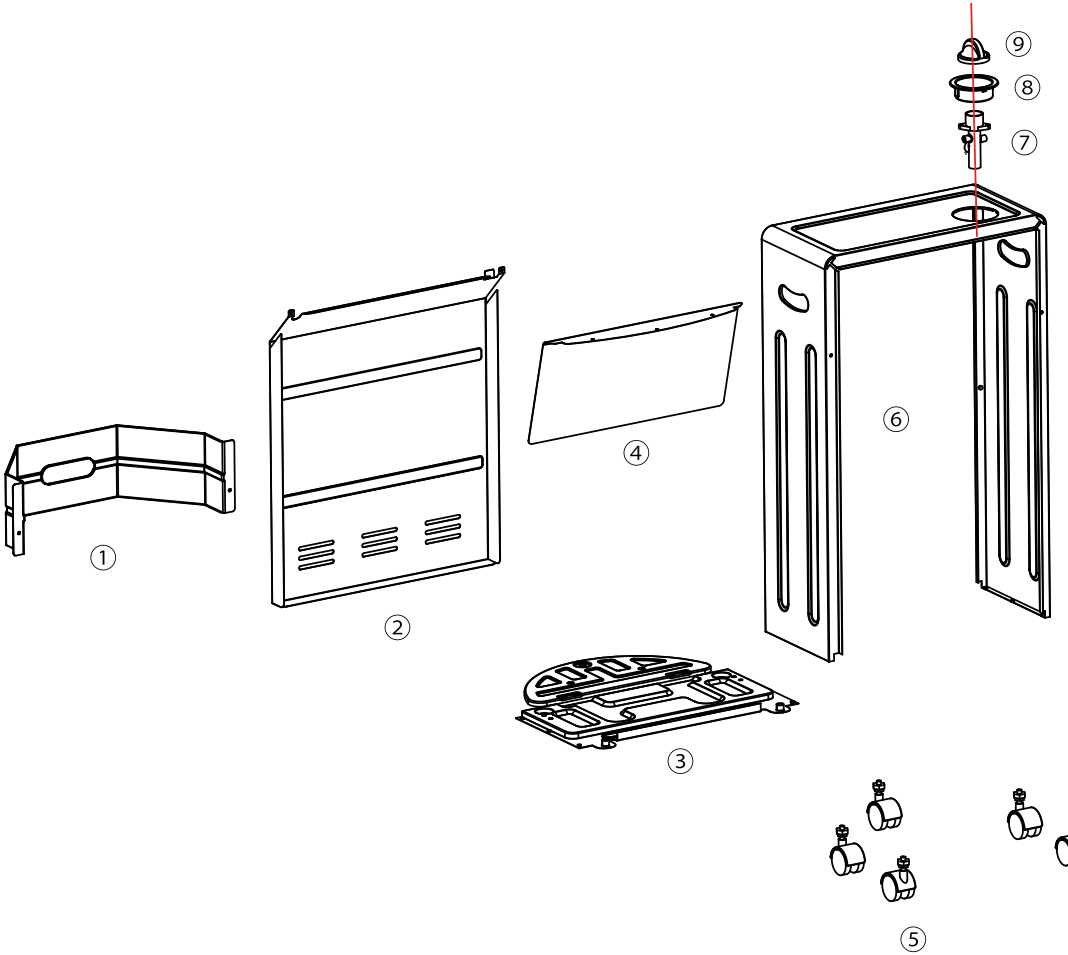



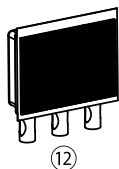
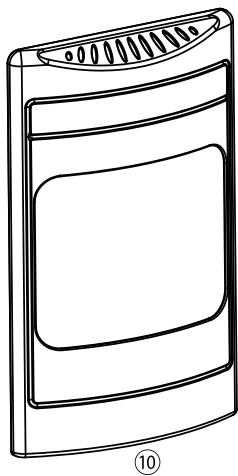

12



11

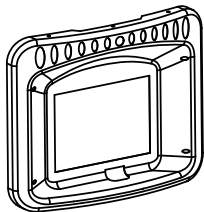

13

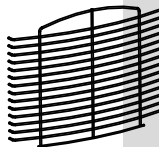

14

NO.	Part Name
1	Bottle guard
2	Zinc plate
3	Bottom plate
4	Insulation board
5	Wheel
6	Main body
7	Valve
8	Plastic knob base
9	Knob
10	Front Panel
11	ODS
12	Burner
13	Enamel panel
14	Grilled net

## ASSEMBLY INSTRUCTIONS

1. Remove the 2 screws and the 2 securing nuts connecting the rear guard to the heater base. Set the 2 screws and 2 nuts aside for later use. (See Fig.B)

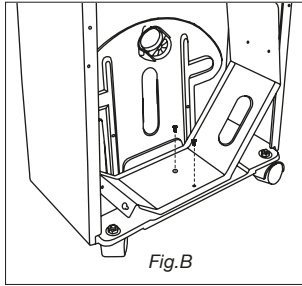

*Screws and Nuts from Step 1 will be used in Step 5.*

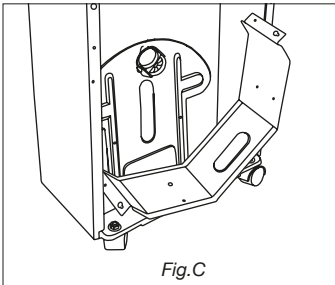

2. Remove the rear guard from the heater base and set aside. (Fig.C)

3. Set the cylinder support down onto the cylinder base. (Fig.D)

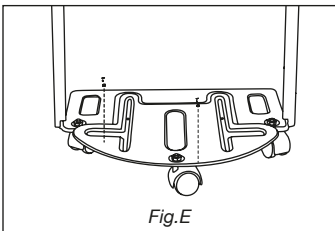
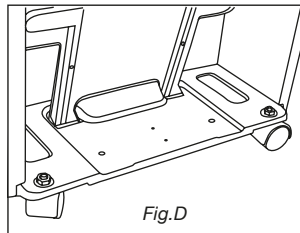

4. Secure the cylinder support to the cylinder base using the 2 screws and nuts which you removed in Step 1. (Fig.E)

4. Push the provided control knob onto the shaft aligning the red marked indicator with the off position. (Fig.J)

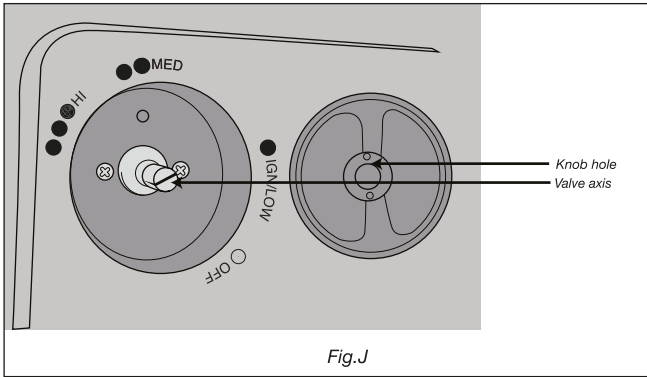

## USING YOUR HEATER

This heater can be regulated to three different heat selections: '●LOW', '●●MED' and '●●●HI'

1. Open the cylinder valve by turning the cylinder valve to the left. (*anti clockwise*)
2. Press the control knob down at the '○OFF' position. Hold the control knob down for ±10-15 seconds.
3. While holding it down, turn the control knob anti-clockwise to Ignite/Low. The heater should make a click sound and you should see a spark. The pilot flame should ignite. Once the pilot flame ignites hold down the knob for another 10-15 seconds.
4. Repeat step 3 if the pilot flame does not stay lit. This may require more than one attempt.
5. Once the pilot flame and centre panel are burning, you can select the settings '●● MED' or '●●● HI' by depressing the knob slightly and turning it to the desired setting.

This heater must be turned off using the control knob first (*Figure K*) and only then closing the cylinder valve.



*How to ignite  
your heater*



*[http://www.youtube.com/watch?v=hVD\\_S7G6mkYE&feature=plcp](http://www.youtube.com/watch?v=hVD_S7G6mkYE&feature=plcp)*

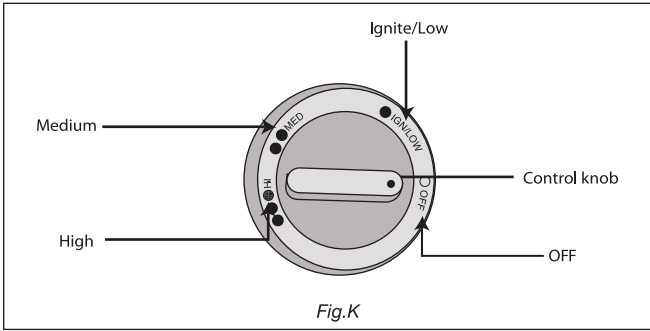

This heater has a positive OFF valve. Use the control knob to turn it OFF before closing the cylinder valve.

## CHANGING YOUR CYLINDER

Make sure your cylinder valve is closed (by turning it clockwise). Allow the heater to fully cool before replacing the cylinder. Open the rear of the heater to expose the cylinder. (Figure L)

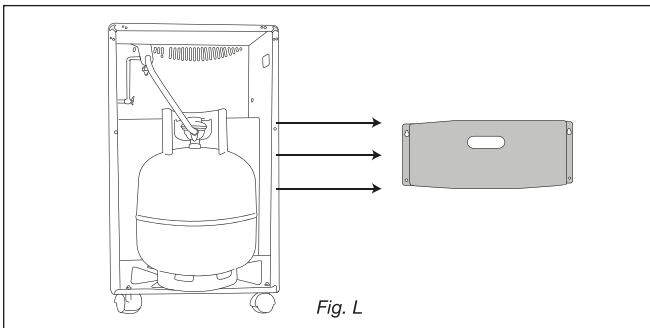

Remove and replace the cylinder. ALWAYS check that the regulator-sealing washer (nose cone) is intact and in place before reattaching the regulator to a cylinder. (Figure B - Page 3) DO NOT attempt to remove the regulator while the heater is on or if the cylinder valve is not closed.



*Take note: On first lighting a new cylinder or connecting a cylinder after it has been refilled; you may have to depress the control valve for a longer period of time.*



*Never attempt to remove the regulator if the heater is on or if the cylinder valve is not properly closed.*

## MAINTENANCE

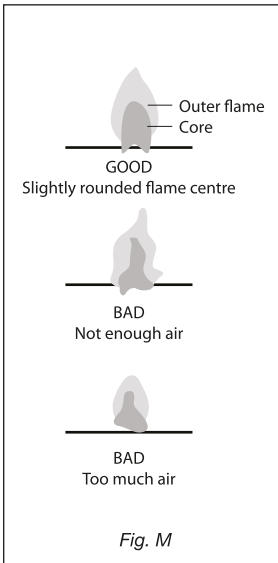

- Always make sure the heater is OFF and cool, with the cylinder valve closed, before conducting any maintenance.
- Your heater should be checked once a year by a qualified technician.
- If faults are suspected or detected, stop using the heater and contact ALVA.
- Clean the exterior and storage area of your heater when required to remove dust and prevent lint build up.
- DO NOT use abrasive products to clean the heater; these may damage the paint work.
- While in operation the pilot flame should be steady. If it flickers or is yellow the heater needs to be serviced. (*Fig. M*)

If any part of the heater is in need of replacing, use only original Alva parts. Using any other spare parts is dangerous and will void the warranty.

When the heater is not going to be used for an extended period of time, keep it covered or in its box, to prevent dust from settling on the panels. When removing the heater from storage, use a vacuum cleaner to vacuum the panels before re-use.

## FREQUENTLY ASKED QUESTIONS

- Q:** Why is there an odour when I use a gas heater?
- A:** All gas appliances give off an odour. This could be harmful if inhaled for extended periods of time. This "smell" is normal, and it does not mean that you have a gas leak. The smell of raw gas (just before you ignite the appliance) differs from the smell coming from the heater when it is in use. The odour is added to allow easy gas detection.

**Q: Why must there be ventilation when using a gas heater?**

A: Whenever fuel (LP Gas in this case) is burned, ventilation is needed. Any fire needs oxygen to burn. Think of a fireplace, you require a chimney or flue for the smoke to exit the house. Even though a gas heater does not generate smoke, it still generates carbon monoxide and carbon dioxide, which can be dangerous if not diluted by fresh air. Always ensure adequate ventilation by leaving a door or window open in the same room.

**Q: When I open a door or window for ventilation won't I get cold?**

A: The Alva GH312 is an infrared radiant gas heater. Infrared heaters heat objects as well as the air. This means, that even though you have cooler air coming into your room, the infrared heater will warm the room and make sure that you do not feel the cold.

**Q: How long will the gas in my cylinder last?**

A: This depends on how you use your heater. It is easy to calculate your gas consumption. Take the capacity of the gas cylinder in grams (i.e. 9000g for a 9kg cylinder) and divide it by the gas consumption of the heater, on your desired setting (*refer to the Specifications section in this manual (page 13)*). The answer to the calculation is the approximate number of hours that your heater will burn for.

**Q: I just took my heater from storage, but there seems to be a blue flame rolling on the panels. Is my heater faulty?**

A: It is normal for dust to settle on the panel. When this happens, the heater will not burn properly at first, giving the appearance of a blue flame running on the panel. This might happen when you first buy the unit after you have stored it. There is nothing wrong with the heater. Simply burn the dust off the panels by letting the heater run on 'Position 3' for between 5 and 15 minutes. The panels should eventually settle and burn red.

**Q: What do I do if I have an over-filled cylinder?**

A: The best method to determine if your cylinder is over-filled is to weigh it. Subtract the 'tare' mass from the cylinder weight – this gives you the weight of your gas. If this gas weight exceeds your cylinder design weight (9kg) then return the cylinder to your gas supplier.



*If you are still unable to correct the problem with the information in this guide, then you need to contact your nearest dealer or manufacturer.*



*How to test if your cylinder is overfilled*



<http://www.youtube.com/watch?v=YavsYE8nzCw&feature=plcp>

## SPECIFICATIONS

Model	GH312 -N
Type of Gas	LPG
Operating pressure	2.8kPa
Injector size	0.59 mm
Gas Consumption Position 3 (3 panels) Position 2 (2 panels) Position 1 (1 panel)	305gr/hr 175gr/hr 90gr/hr
Heat output	4.2kW
This heater has been tested and is LPGSASA approved under specifications SANS 1539 (appliance), SANS 1237 (regulator) and SANS 1156-2 (hose).	

Model	GH320
Type of Gas	LPG
Operating pressure	2.8kPa
Injector size	0.59 mm
Gas Consumption Position 3 (3 panels) Position 2 (2 panels) Position 1 (1 panel)	305gr/hr 175gr/hr 90gr/hr
Heat output	4.2kW
This heater has been tested and is LPGSASA approved under specifications SANS 1539 (appliance), SANS 1237 (regulator) and SANS 1156-2 (hose).	

Model	GH321
Type of Gas	LPG
Operating pressure	2.8kPa
Injector size	0.59 mm
Gas Consumption Position 3 (3 panels) Position 2 (2 panels) Position 1 (1 panel)	305gr/hr 175gr/hr 90gr/hr
Heat output	4.2kW
This heater has been tested and is LPGSASA approved under specifications SANS 1539 (appliance), SANS 1237 (regulator) and SANS 1156-2 (hose).	

## TROUBLE SHOOTING GUIDE

TROUBLE	CAUSE	REMEDY
Odour	Combustion	N/A - The combustion process will always cause an odour
Strong odour	Incorrect gas mixture	Obtain LPG only from reputable LPG dealers
	Unburned gas leak	Perform a leak test Always ensure there is proper ventilation
Burns then dies	Over-filled cylinder	Return to gas supplier
	Ventilation	Make sure the room has adequate ventilation
	Empty cylinder	Replace with a full cylinder
Heater does not light up	Empty cylinder	Replace with a full cylinder
	No gas flow	Open cylinder valve

## FEATURES

### **Positive off:**

The heater can be switched off at the control knob of the unit.

### **Oxygen Depletion Sensor (ODS):**

A safety feature that shuts the heater off if the carbon monoxide levels in the room reach 200 parts per million.

### **Flame Failure Safety Device:**

A safety feature that shuts the gas flow off completely if the pilot flame dies for any reason.



*Should you experience problems with this gas heater, carry out the necessary checks as per the Trouble Shooting Guide . If you are still unable to correct the problem with the information in this guide, then you need to contact your nearest dealer or manufacturer.*



## AFTER SALES SERVICE

MANUFACTURED FOR AND DISTRIBUTED BY  
Alva, a division of Stingray Accessory Manufacturers (Pty) Ltd  
P.O. Box 30014  
Tokai, 7966  
Tel: 021 442 1540  
E-mail: [info@stingray.co.za](mailto:info@stingray.co.za)  
[www.alva.co.za](http://www.alva.co.za)  
 [/alvagas](https://www.instagram.com/alvagas)  
 [www.facebook.com/AlvaGas](https://www.facebook.com/AlvaGas)

**TOLL FREE NUMBER**  
**086 100 ALVA (2582)**