

# ALVA

## OUTDOOR FREESTANDING CANISTER HEATER

WITH LONG LIFE CERAMIC BURNER • BUILT-IN SAFETY  
FUNCTIONS AND VARIABLE HEAT CONTROL

CRC1108



Your world is better with Alva

PLEASE READ THIS MANUAL CAREFULLY BEFORE  
USE AND ALWAYS OPERATE THIS PRODUCT  
ACCORDING TO THE INSTRUCTIONS

RETAIN THIS MANUAL FOR FUTURE REFERENCE

IT IS ILLEGAL AND DANGEROUS TO CHANGE OR  
MODIFY ANY PART OF THIS APPLIANCE



APPROVED FOR USE IN  
SOUTH AFRICA

Manufactured for  
and distributed by:

# ALVA

A division of Stingray Accessory Manufacturers (Pty) Ltd | P.O. Box 30014, Tokai, 7966  
+27 21 442 1540 | info@stingray.co.za | www.alva.co.za  
TOLL FREE NUMBER: 086 100 ALVA (2582)

f /AlvaGas

@alvagas

## IMPORTANT SAFETY INFORMATION

As with all gas appliances, misuse of this appliance or failure to fully follow these instructions may cause fire, injury or death. Please read all the instructions before using your gas heater.

- THIS UNIT MUST BE THOROUGHLY CHECKED BEFORE USE.
- Ensure that all the gas fittings are correctly and firmly fitted before every use.
- DO NOT use this heater if you do not clearly understand the instructions and/or how to operate the controls.
- Phone the customer care line at 086 100 ALVA (2582) or email [info@stingray.co.za](mailto:info@stingray.co.za) for assistance.
- DO NOT use this heater in an enclosed area, which could restrict airflow, as this is a flue-less heater (It does not have a fixed chimney).
- DO NOT operate this heater in a bedroom, caravan, boat or any area less than 80 cubic meters (roughly 5 x 5 metres).
- DO NOT leave the heater unattended while in use.
- Ensure that the gas supply is turned OFF after use and while the heater is unattended.
- DO NOT move the heater while in use.
- DO NOT place objects on or against the heater.
- DO NOT attempt to use the heater as a stove.
- DO NOT use a naked flame to test for leaks. Follow the Leak Testing procedure outlined under 'LEAK TEST'.
- NEVER use this heater with a butane cartridge other than that specified.
- DO NOT touch the dress guard (front wire grill), as it gets very hot, while in use or after it has been switched off and is cooling. The dress guard does not give protection. No part of the dress guard should be removed or changed.
- DO NOT use a heater you suspect is faulty.
- For safety reasons, only a qualified technician may execute maintenance and repairs. The guarantee for the heater will be rendered void if the heater is serviced or repaired by any one other than an Alva appointed technician.
- The heater should be inspected once a year by a qualified technician, to make sure the unit is safe and fault free.
- The operator is responsible for the safety of all third parties while the heater is in use.
- Dispose of all polythene packaging carefully and keep out of the hands of young children.
- Great care has been taken during production to remove sharp edges, but you should handle all components with care to avoid possible injury.
- Always position the heater on a firm, level, and heat proof surface, away from wooden fences, overhanging tree branches, and other inflammable materials



*Please read the instructions carefully before use.*

*Retain this manual for future reference.*

*The recommended positioning of a gas heater in any living environment. Always have a clearance of at least 200mm on the sides and back and  $\pm 1000$ mm (1m) in front of it.*

- During operation, this product can be a source of ignition. Never use the heater in spaces that contain or may contain volatile or airborne combustibles, or products such as gasoline, solvents, paint thinner, dust particles, or unknown chemicals.
- Only 220g butane gas cartridge can be used for the heater.
- Keep out of reach of children and pets.
- When you smell gas or hear a hissing sound, turn the control knob to the "OFF" position and release the lever. DO NOT use the heater and contact 086 100 ALVA (2582) if the problem cannot be solved.
- Keep a fire extinguisher handy.
- As an additional safety measure, we suggest that the gas cartridge be removed when the heater is not in use.

## INDEX

WARRANTY	2
GENERAL INFORMATION	2
LEAK TEST	3
PARTS LIST	4
USING YOUR HEATER	5
MAINTENANCE	7
FREQUENTLY ASKED QUESTIONS	8
WARNINGS	9
TROUBLE SHOOTING GUIDE	11
FLASHBACKS	12
SPECIFICATIONS	12
AFTER SALES SERVICE	12

### KEY



*Important information*



*Cautions and warnings.*



*Danger*



*Contact an approved ALVA technician.*



*Do It Yourself*



*Instructional video available*

## WARRANTY

PLEASE RETAIN YOUR PROOF OF PURCHASE FOR WARRANTY CLAIMS.

ALVA warrants this appliance to be free of defects in material and quality for a period of 12 months from date of original purchase. This warranty covers the intended use of this appliance – within a domestic setting and not for commercial or industrial purposes. Any damage caused by wilful abuse, tampering, modification or unauthorized repair will not be warranted.

Please retain all packaging material, as items returned without original packaging material may be subject to a withholding fee. Where this appliance is found to be defective, damaged, broken, or does not work correctly for the intended purpose, you must return the appliance to the retailer from where it was purchased. The warranty will only be effected with valid proof of purchase. Failure to provide the proof of purchase will most likely result in the repair or service required being chargeable.

If you have any questions while setting up or using this heater, please visit [www.alva.co.za](http://www.alva.co.za) or call 086 100 ALVA (2582) or e-mail [info@stingray.co.za](mailto:info@stingray.co.za)

## GENERAL INFORMATION

Before using this heater, please read through this manual and make sure you understand everything. If you are not sure, please call 086 100 2582 or visit [www.alva.co.za](http://www.alva.co.za) for help. This heater is a safe and efficient form of heating when used according to these instructions.

Reading and understanding this manual should give you a good indication of what to expect from your Alva butane heater.

If this product is not what you want or need, please help Alva and the environment by not damaging or destroying any part of the packaging, the manual or the Styrofoam inserts. Always keep your proof of purchase.

Keep these instructions for future use. If you lose this copy, you can obtain a new copy from your dealer or online at [www.alva.co.za](http://www.alva.co.za)



*Thank you for your purchase of this canister heater. Please read these instructions carefully before use and keep them in a safe place, for future reference.*



*Not using butane and/or butane appliances according to the instructions is extremely dangerous and can lead to property damage, injury or death.*

## LEAK TEST

The leak test must be carried out in a well-ventilated area, free from any flames or other sources of ignition.

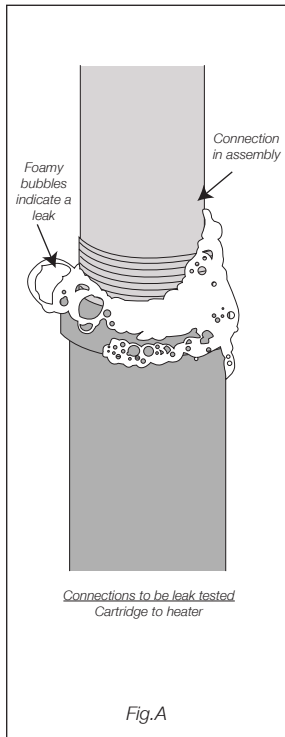

- With the cartridge installed in the stove. Open the ignitor knob.
- Brush the connections (stove to cartridge) with a solution of equal parts soap and water (make sure it's foamy).
- A stream of bubbles forming indicates a gas leak. (See Fig.A)
- If bubbles appear, turn the ignition knob OFF, 'O', (clockwise) and release the cartridge lock lever to the upward position and remove and isolate the gas cartridge.
- Re-install the gas cartridge, making sure the cartridge slot is pointing upward and retry the leak test..
- If you are unsure or if you cannot install the cartridge without a leak occurring place the butane cartridge outside in a cool, well-ventilated area and contact Alva on **086 100 ALVA (2582)**.
- A leak between the stove and canister can lead to a fire, which is very dangerous and can result in extensive injury or even death.



**PRECAUTIONS**  
*Leak test all connections after each canister installation.*



**NEVER** check for leaks with a match or open flame



*Any Butane cartridge not connected for use must not be stored in the vicinity of this or any other appliance.*

## PARTS LIST

Please check each component against the parts list prior to assembly.

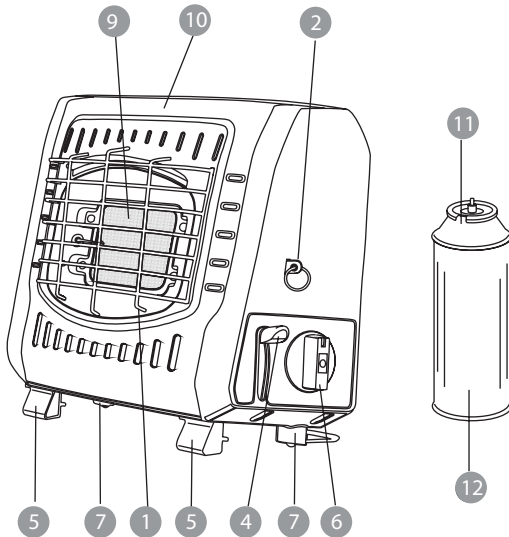
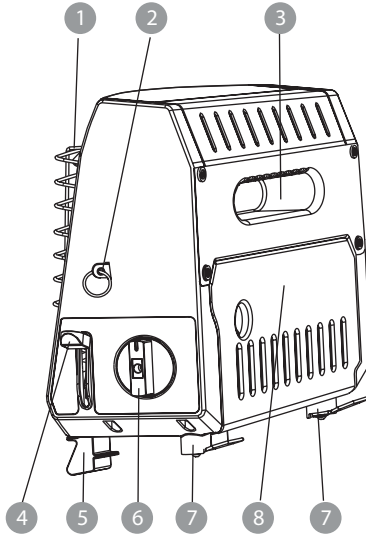

1	Wire frame
2	Assister bar
3	Handle
4	Cartridge level
5	Front foot
6	Control knob
7	Rear foot
8	Cartridge cover
9	Ceramic slate
10	Panel
11	Notch
12	Gas Cartridge

## USING YOUR HEATER

Please read the instruction manual before operating the heater. Failure to follow the precautions and instructions may result in death, serious injury and property loss. Only persons who understand and follow the instructions should use the gas heater.

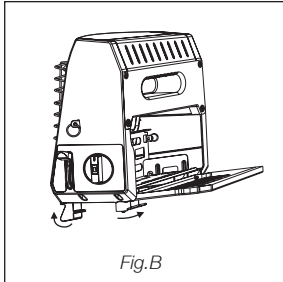

1. Pull out the four feet. Put the heater on a firm and flat surface. Make sure the control knob is at the "OFF" position and the level knob is at the "RELEASE" position. (Fig.B)

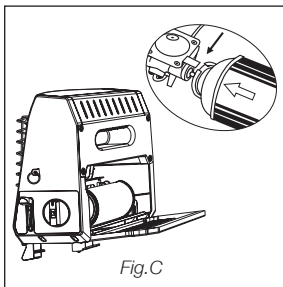

2. Please use the specified gas cartridge and fit it according to Fig.C.

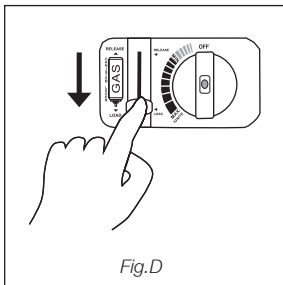

3. Make sure the control knob is in the "OFF" position and then depress the cartridge level to "LOAD". (Fig.D)



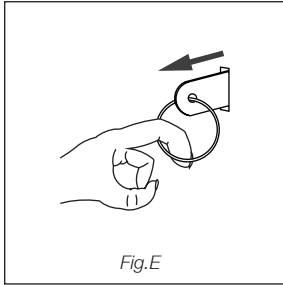

Fig.E

4. Pull out the Assister Bar. (Fig.E)

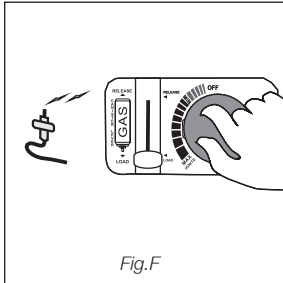

Fig.F

5. Turn the control knob anticlockwise to "IGNITE", till you hear an audible "click". If the heater ignites, release the assists bar. (Fig.F)

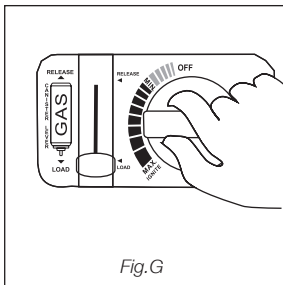

Fig.G

6. If the heater fails to ignite, then release the control knob and re-attempt Step 5, after waiting 20 seconds. Once ignited select your desired heat setting. (Fig.G)

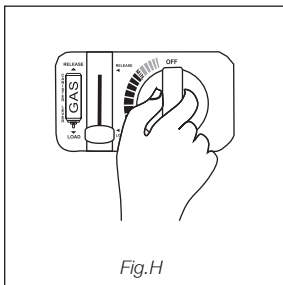
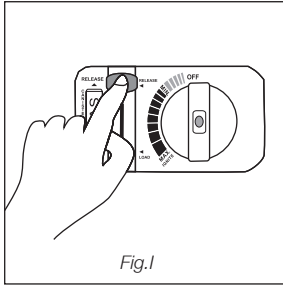
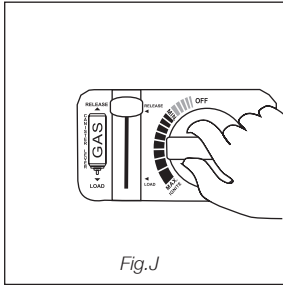

Fig.H

7. Turn the control knob to "OFF" to close the gas supply. (Fig.H)



8. Lift the Cartridge Level to the "RELEASE" position to release the cartridge, take out the butane canister. (Fig. I)



9. After removing the cartridge, there will still be some gas in the heater system. To release this gas turn the control knob to "MAX". Once finished turn the control knob to the "OFF" position (Fig. J)

## MAINTENANCE

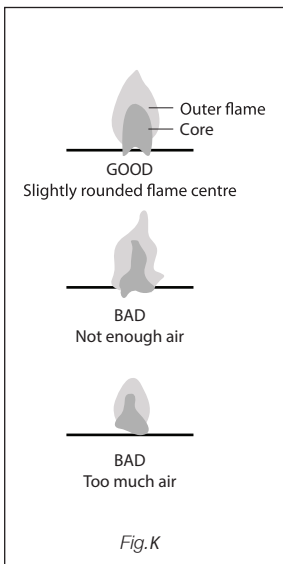

- Always make sure the heater is OFF and cool, with the cartridge removed, before conducting any maintenance.
- Your heater should be checked once a year by a qualified technician.
- If faults are suspected or detected, stop using the heater and contact ALVA.
- Clean the exterior and storage area of your heater when required to remove dust and prevent lint build up.
- DO NOT use abrasive products to clean the heater; these may damage the paint work.
- While in operation the flame should be steady. If it flickers or is yellow the heater needs to be serviced. (Fig. K)

If any part of the heater is in need of replacing, use only original Alva parts. Using any other spare parts is dangerous and will void the warranty. When the heater is not going to be used for an extended period of time, keep covered or in its box, to prevent dust from settling on the panels. When removing the heater from storage, use a vacuum cleaner to clean the panels before re-use.

## FREQUENTLY ASKED QUESTIONS

**Q: Why is there an odour when I use a gas heater?**

A: All gas appliances give off an odour. This could be harmful if inhaled for extended periods of time. This “smell” is normal, and it does not mean that you have a gas leak. The smell of raw gas (just before you ignite the appliance) differs to the smell coming from the heater when it is in use. The odour is added to allow easy gas detection.

**Q: Why must there be ventilation when using a gas heater?**

A: Whenever fuel (Butane in this case) is burned, ventilation is needed. Any fire needs oxygen to burn. Think of a fireplace, you require a chimney or flue for the smoke to exit the house. Even though a gas heater does not generate smoke, it still generates carbon monoxide and carbon dioxide, which can be dangerous if not diluted by fresh air. Always ensure adequate ventilation.

**Q: How long will the gas in my cartridge last?**

A: This depends on how you use your heater. It is easy to calculate your gas consumption. Take the capacity of the gas cartridge in grams (i.e. 220g) and divide it by the gas consumption of the heater, on your desired setting (*refer to the Specifications section in this manual (page 12)*). The answer to the calculation is the approximate amount of time that your heater will burn for (in hours).

**Q: I just took my heater from storage, but there seems to be a blue flame rolling on the panels. Is my heater faulty?**

A: It is normal for dust to settle on the panel. When this happens, the heater will not burn properly at first, giving the appearance of a blue flame running on the panel. This might happen when you first buy the unit after you have stored it. There is nothing wrong with the heater.

Simply burn the dust off the panels by letting the heater run on 'MAX' for between 5 and 15 minutes.  
The panels should eventually settle and glow red.

## WARNINGS

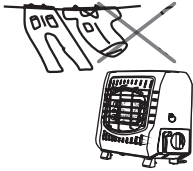

*DO NOT* use the heater to dry clothing or other flammable items.

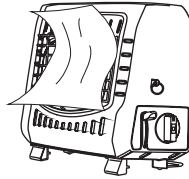

*DO NOT* cover the heater or parts of the heater when in use.

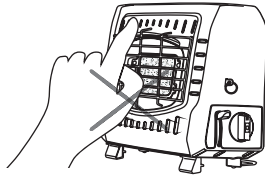

*DO NOT* touch any parts of the heater after use, wait until the heater has cooled.

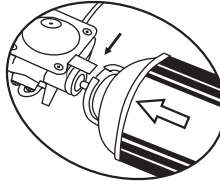

Always align the gas cartridge collar with the locator tab.

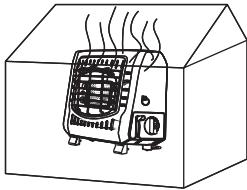

*Recommended for indoor use*



*DO NOT* puncture, pierce or incinerate the cartridge, even after use.

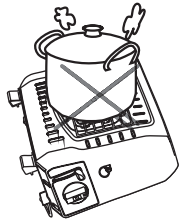

*DO NOT use this heater for any purpose other than that it is originally intended for.*

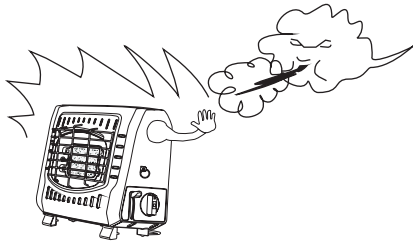

*DO NOT use this heater in windy conditions.*

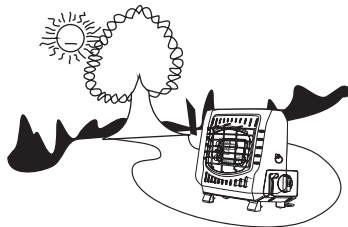

*DO NOT store the heater in direct sunlight.  
Always store the appliance in a weather protected, shady area.*

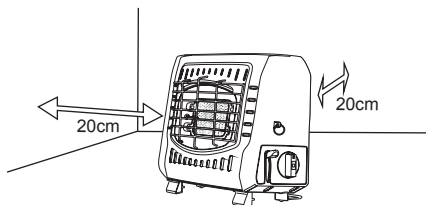

*Always ensure the heater is placed on a heat proof surface  
away from flammable materials.*

## TROUBLE SHOOTING GUIDE

### Trouble and Causes

TROUBLE CAUSES	Cartridge will not install	No gas supplied at "MAX" position	Smell gas at "O" position	Low flame	Uneven flame	No ignition/ faulty ignition	Extinguished during operation
Igniton knob is not turned to OFF "O" position	●						
Safety Device Activated		●				●	●
Ignition Knob malfunction		●	●	●		●	
Clogged nozzle		●		●		●	
Cartridge incorrectly installed	●	●	●			●	
Clogged burner holes				●	●	●	
Bent or rusty electrode						●	
No gas		●		●	●	●	●
Not easily ignited						●	

### Trouble shooting

CAUSES	SOLUTIONS
Igniton knob is not turned to "O" position	Turn ignition knob completely to "O" and reset cartridge
Ignition Knob malfunction	Contact 086 100 ALVA (2582)
Clogged nozzle	Contact 086 100 ALVA (2582)
Cartridge incorrectly installed	Fit cartridge guide into cartridge slot
Clogged burner holes	Clean with a metal brush
Bent or rusty electrode	Clean electrode
No gas	Replace Butane cartridge
Not easily ignited	Pull out the assistance bar when igniting



*If you are still unable to correct the problem with the information in this guide, then you need to contact your nearest dealer or manufacturer.*

*Should you experience problems with this gas heater, carry out the necessary checks as per the Trouble Shooting Guide. If you are still unable to correct the problem with the information in this guide, then you need to contact your nearest dealer or manufacturer.*

## FLASHBACKS

In the event of flash back whilst the appliance is in use, turn all the controls to the 'OFF' position.

Wait 5 minutes before attempting to relight the appliance. If the problem persists, check for blockages and ensure the cartridge has been installed correctly. If problem persists do not try to rectify the problem yourself as this could result in serious injury and/or property damage. Remove the cartridge from the appliance.

Store the appliance in a clean and dry environment.

Do not store your gas cartridge indoors. Store in a well ventilated area away from direct sunlight or an electrical source.

## SPECIFICATIONS

Model	ALVA CCR108
Type of Gas	Butane Gas
Required Cartridge	220g
Approximate power	1.2kW
Gas Consumption at max	100gr/hr

## FOR USE ONLY WITH AN EN417 APPROVED CANISTER

## AFTER SALES SERVICE

MANUFACTURED FOR AND DISTRIBUTED BY  
Alva, a division of Stingray Accessory Manufacturers (Pty) Ltd  
P.O. Box 30014  
Tokai, 7966  
Tel: 021 442 1540  
E-mail: [info@stingray.co.za](mailto:info@stingray.co.za)  
[www.alva.co.za](http://www.alva.co.za)  
@/alvagass  
www.facebook.com/AlvaGas

TOLL FREE NUMBER **086 100 ALVA (2582)**



*Should you experience problems with this gas heater, carry out the necessary checks as per the Trouble Shooting Guide .*

*If you are still unable to correct the problem with the information in this guide, then you need to contact your nearest dealer or manufacturer.*