

ALVA

INFRARED WALL PANEL HEATER

AWH100



Your world is better with Alva

PLEASE READ THESE INSTRUCTIONS CAREFULLY
BEFORE USING THIS APPLIANCE AND RETAIN THIS MANUAL
FOR FUTURE REFERENCE.

As with all electrical appliances, certain care is required for safe use.
This heater is designed to operate safely and provide user comfort.

Failure to read and understand these instructions is dangerous and
can lead to property damage, injury and even death.

This appliance must not be modified in any way - doing so is illegal and will
make the appliance unsafe as well as cancel your warranty.

Manufactured for
and distributed by:

ALVA

A division of Stingray Accessory Manufacturers (Pty) Ltd | P.O. Box 30014, Tokai, 7966 | +27 21 442 1540
info@stingray.co.za | www.alva.co.za | TOLL FREE NUMBER: 086 100 ALVA (2582)



/AlvaGas



/alvagas

IMPORTANT SAFETY INFORMATION

As with all appliances, misuse of this appliance or failure to fully follow these instructions may cause fire, injury or death. Please read all the instructions before using your heater.

- Before using this appliance check that the voltage indicated on the type plate corresponds to your mains supply voltage.
- DO NOT use this heater with a programmer, timer or any other device that switches the heater on automatically. There is a fire risk if the heater is covered or positioned incorrectly.
- Always disconnect the heater from the electricity mains when not in use, during installation, cleaning.
- Always ensure that the power cord is kept away from the body of the heater. The heater body will get very hot while in use and can melt the cable.
- Always inspect the power cord for signs of wear or damage. If wear or damage is noted, a suitably qualified person should replace it immediately. Failing to do so is a hazard and may lead to fire and/or electrocution/electric shock and/or property damage and/or death.
- NEVER allow the cord to come into contact with wet or hot surfaces or become twisted.
- DO NOT damage and DO NOT kink the power cord.
- DO NOT cover or obstruct the heater when in use.
- DO NOT insert any objects through any slot or opening in the heater.
- Users must not disassemble the heater, or change/substitute any parts of this heater; if the heater is faulty it is Extremely dangerous to use it.
- Keep the heater a distance of at least 1 meter from any combustible material, such as furniture, curtains, bedding, clothes or paper.
- Keep the heater clean. DO NOT allow objects to enter the ventilation, as this may cause electric shock, fire or damage the heater.
- NEVER touch the appliance with wet or damp hands or feet.
- NEVER expose the appliance to atmospheric conditions (rain, sun, etc)
- DO NOT use the appliance for anything other than its intended use.
- DO NOT use this heater in the immediate surroundings of a bath, a shower or a swimming pool.



Please read the instructions carefully before use.

Retain this manual for future reference.

This appliance must not be modified in any way - doing so is illegal and will make the appliance unsafe as well as void your warranty.

- Any repairs that need to be done to the heater must be referred to an authorized service agent only.
- DO NOT connect the appliance to multiple extension cords or multiple outlets.
- This heater is not equipped with a device to control the room temperature. DO NOT use this heater in small rooms when they are occupied by persons not capable of leaving the room on their own, unless supervised.
- This heater must not be located immediately below a socket-outlet.
- Keep away from children.
- Some parts of this product can become very hot and cause burns. Particular attention has to be given where children and vulnerable people are present.

Ensure that children do not play with this heater. This appliance is not intended or designed for use by persons (including children) with reduced physical, sensory or mental capabilities or lack of experience and knowledge, unless they are supervised or given instruction concerning use of this appliance by a person responsible for their safety. If the power supply cord is damaged, it must be replaced with a special cord or assembly, available from the manufacturer or its service agent.

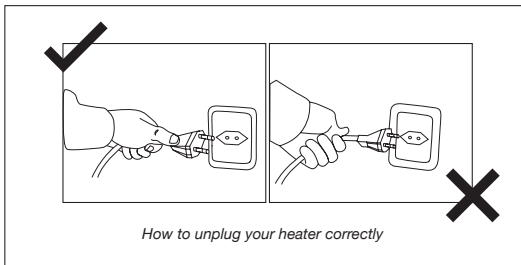

How to unplug your heater correctly

To remove from the socket pull on the plug, not the electrical cord



It is unsafe to mount this heater where it is close to a baffle plate or any other combustible material.

Keep combustible materials such as furniture, paper, clothes and curtains at least 1m from the front, sides and rear of the heater.

INDEX

WARRANTY	2
GENERAL INFORMATION	2
PARTS LIST	3
INSTALLATION	3
USING YOUR HEATER	4
MAINTENANCE	5
TROUBLESHOOTING	5
TECHNICAL DATA	6
AFTER SALES SERVICE	6

KEY



Important information



Cautions and warnings.



Danger



*Contact an approved
ALVA technician.*



Do It Yourself

WARRANTY

PLEASE RETAIN YOUR PROOF OF PURCHASE FOR WARRANTY CLAIMS.

ALVA warrants this appliance to be free of defects in material and quality for a period of 12 months from date of original purchase. This warranty covers the intended use of this appliance – within a domestic setting and not for commercial or industrial purposes. Any damage caused by wilful abuse, tampering, modification or unauthorized repair will not be warranted.

Please retain all packaging material, as items returned without original packaging material may be subject to a withholding fee. Where this appliance is found to be defective, damaged, broken, or does not work correctly for the intended purpose, you must return the appliance to the retailer from where it was purchased. The warranty will only be effected with valid proof of purchase. Failure to provide the proof of purchase will most likely result in the repair or service required being chargeable.

If you have any questions while setting up or using this heater, please visit www.alva.co.za or call 086 100 ALVA (2582) or e-mail info@stingray.co.za

GENERAL INFORMATION

Before using this heater, please read through this manual and make sure you understand everything. If you are not sure, call **086 100 ALVA (2582)** or visit www.alva.co.za for help. This heater is a safe and efficient form of heating when used according to these instructions.

Reading and understanding this manual should give you a good indication of what to expect from your Alva heater. If this product is not what you want or need, please help Alva and the environment by not damaging or destroying any part of the packaging, the manual or the Styrofoam inserts.

Always keep your proof of purchase. Keep these instructions for future use. If you lose this copy, you can obtain a new copy from your dealer or online at www.alva.co.za.

ALVA

Thank you for your purchase of this heater. Please read these instructions carefully before use and keep them in a safe place, for future reference.



Not using appliances according to the instructions is extremely dangerous and can lead to property damage, injury or death.

For indoor use only.

DO NOT use within 1m of any flammable surfaces.

DO NOT store flammable materials near the heater.

PARTS LIST

COMPONENT	QTY
Heater	1
Drill bit (8mm)	1
Wall plugs	4
Screw bolts	4
Caps for bolts	4
Instruction manual	1

INSTALLATION

Open your package and unpack the heater together with the wall mounting accessories pack.

1. Mark the positions of the four holes to be drilled on the wall. (Better install the heater 20cm to 100cm height from the floor to get best performance.)
2. Drill the holes with the drill bit from the accessories pack.
3. Insert the plastic wall plugs into the holes.
4. Install the panel heater onto the four wall plugs matching the four holes in the heater.
5. Screw the four fastening bolts into the plastic wall plugs.
6. Place the caps onto the fastening bolts.
7. To remove the unit from the wall, remove the bolt caps and unscrew the bolts with a screw driver and then take the heater down.
8. Make sure the distance between the bottom of the heater and the floor is no less than 20cm when the heater is installed

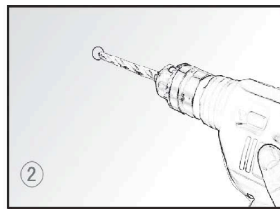
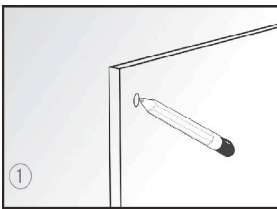

Always ensure that the heater is unplugged when not in use, installing and cleaning.

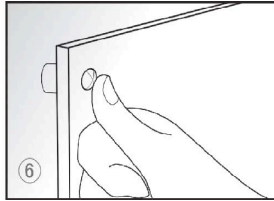
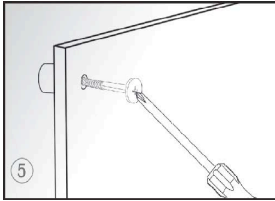
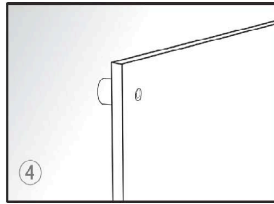
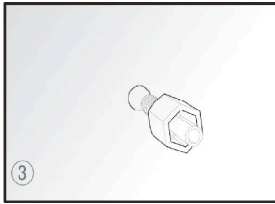

USING YOUR HEATER

To begin to use the heater, please follow these instructions:

1. Check the heater to be sure it is not damaged.
2. Then, plug it in and switch on the illuminated ON/OFF switch.
3. When you do not want to heat the room, just switch it off by the switch and switch the heater off at the plug.

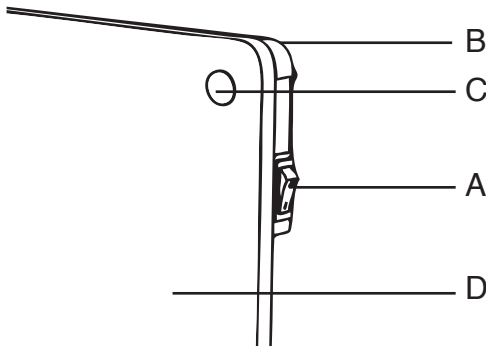

A ON/OFF Switch	C Screw Bolt Cap
B Control Panel	D Heater Body

OPERATION OF THE HEATER

NOTE: It is normal when the heaters are turned on for the first time, or when they are turned on after having not been used for a long period of time the heaters may emit some smell and fumes. This will disappear when the heater has been on a short while.



Before using the heater, make sure you understand the "IMPORTANT SAFETY INFORMATION" section of this manual.

MAINTENANCE

It is necessary to periodically wipe the heater, depending on the placement and environment where it's used.

Be sure the heater is fault free:

1. Check the electric mains lead is properly connected.
 2. Ensure that the mains lead and plug are not damaged.
- Your heater should be checked once a year by a qualified technician.
 - If faults are suspected or detected, stop using the heater and contact ALVA.
 - Clean the exterior of your heater when required to remove dust.
 - DO NOT use abrasive products to clean the heater; these may damage the heater surface.
 - Always make sure the heater is OFF and cool before conducting any maintenance.
 - Keep young children or infirm persons away from any hot surfaces.
 - Always disconnect the heater from the electricity mains when not in use (Page 4).
 - DO NOT submerge the heater in water.
 - DO NOT spray down or rinse the heater with water.

TROUBLESHOOTING

SYMPTOM	CAUSE	SOLUTION
Heater will not turn ON	Not plugged in	Plug in and switch on socket.
	Not switched ON	Switch ON

TECHNICAL DATA

Item number	AWH100
Voltage (V) Hz	220-240V -50/60Hz
Electric power	425W
Insulation protection	
Heating area	12m ²
Dimensions	600 x 10 x 600mm
Weight	5.25 kg

AFTER SALES SERVICE

MANUFACTURED FOR AND DISTRIBUTED BY ALVA,
a division of Stingray Accessory Manufacturers (Pty) Ltd
P.O. Box 30014
Tokai, 7966
Tel: 021 442 1540
E-mail: info@stingray.co.za
www.alva.co.za
 www.facebook.com/AlvaGas

TOLL FREE NUMBER **086 100 ALVA (2582)**